



ROYAL[®]
Trim & Mouldings

INSTALLATION HANDBOOK

Table of Contents

This guide outlines basic installation practices for the installation of Royal PVC trims and mouldings. These products should be installed in accordance with local building codes.

Visual Index	4,5
Storage and Handling	6
Safety	6
Structural Integrity	6
Managing Expansion and Contraction	6,7
Cutting	8
Routing.....	8
Fastening.....	8,9
Finishing	9
Painting and Staining	10,11
Adhesives.....	11,12
Heat Bending	13-18
Water Tables.....	19
Conceal Skirt Board	20
Soffit and Ceilings.....	21-24
Beaded Plank/Wainscoting.....	25
Frieze Board/Band Board/Fascia	26,27
Gable Trim	28
Corners	29,30
Window Trim Construction/Assembly	
Standard Trim Boards.....	31-33
Conceal Trim Boards	34
New Construction Surround	35,36
Garage Door Stop	37
Column Wraps	38-41
Cleaning PVC Trim.....	42
Frequently Asked Questions	43-45

Visual Index

Window Trim
Pgs. 31-36

Garage Door Stop
Pgs. 37

Water Tables
Pgs. 19



Frieze Boards/Gable Trim/
Band Boards
Pgs. 17-18

Soffit/Ceiling
Application
Pgs. 21-24

Corners
Pgs. 29,30

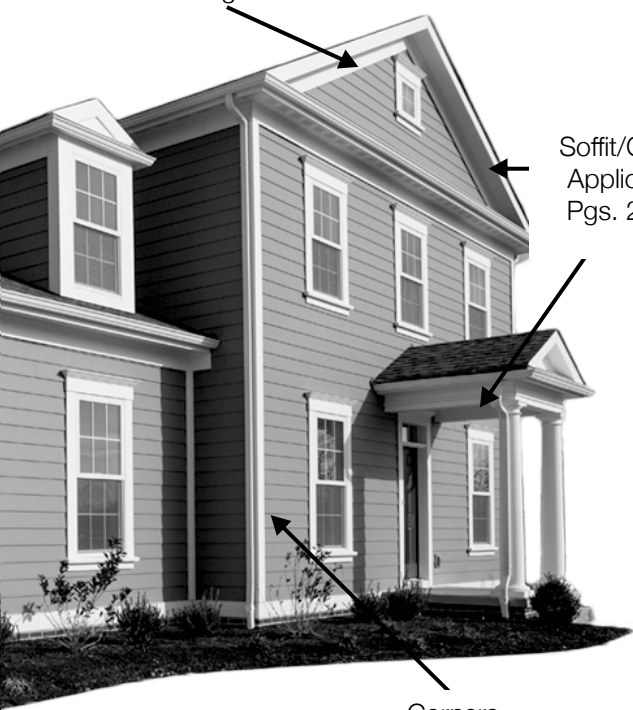

Storage and Handling

- Royal trim and moulding should be stored off the ground, fully supported on a flat surface.
- Never place Royal trim and mouldings directly on blacktop or other surfaces that can develop excessive heat.
- Store in a well ventilated area.
- Keep under shipping shroud, white side up during warehousing.
- For products with protective film, remove film directly after installation.
- Protective film should not be left exposed more than 90 days.

Safety

- Wear safety glasses for all cutting and nailing operations.
- Follow standard safety practices for using power tools, ladders, etc.
- Cut and mill in a well-ventilated area.

Structural Integrity

- Royal trim and mouldings are not to be used as structural products in load bearing applications. PVC boards must always be supported by wood or other structural materials.

Managing the expansion and contraction

- PVC products expand and contract through temperature changes. This movement must be taken in consideration when working with the products.
- The amount of movement of a board is in relation to it's length. Therefore, the longer the board, the more movement is likely.
- Window trim is typically assembled prior to installation on the wall and are small enough not to need additional expansion joints, etc.
- See drawing on page 7 for guidance on longer pieces.

Trim Board/Fascia Joints

When joining boards in areas such as under eaves on fascia, a shiplap joint is recommended with the exception of at corners; a mitered corner will give the best appearance.

Scarf joints are not recommended.

Miters

When mitering a corner, the following rules apply:

- The trim board with a mitered end should be no longer than 4'
- Always glue the ends of the boards with PVC cement.
- Place a fastener 2" from the seam on both sides.

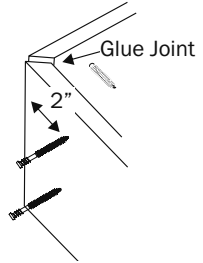

Managing expansion/contraction on longer runs

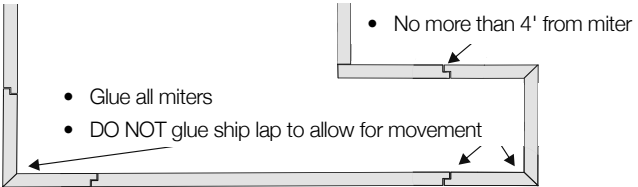

Place a fastener 2" from the seam on both sides

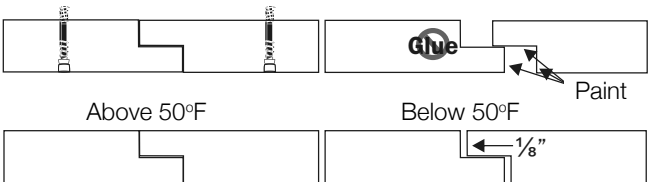

Cutting

- Carbide edge blades give the best results.
- The use of improper tooling or poor board support may result in rough cut edges.
- Fine tooth jig saw blades (6tpi or less) may cause the fusing of boards together at the cut line.

Routing

- Use standard wood working carbide-tipped router bits.
- Secure the trim to a bench or table when routing to minimize "chatter."
- Once the routing is complete, the cut can be smoothed using 220-320 grit sand paper. This will seal the cut edge and make it more resistant to dirt.

Fastening

- Use fasteners designed for wood trim. They should have thin shanks, blunt points, and full round heads.
- Fasteners should penetrate 1¹/₄" into substrate.
- Fasteners should be positioned no less than 3³/₄" or more than 2" from end of board.
- Fasteners must be weather resistant, such as stainless steel or hot dipped galvanized.
- Pneumatic guns can be used. Air pressure should be adjusted based upon gun, temperature, substrate, etc. (80-100psi typical).
- Trim should be fastened to a flat solid surface.
- In cold weather below 40°, pre-drilling may be necessary.
- Do not use brads or wire nails. Staples can only be used to fasten beaded planking.
- For fastening soffit, refer to page 22.

Recommended Screws

- Fasten Master Cortex Hidden Fastening System (for use with minimum $\frac{5}{8}$ " thickness material)
- Starborn Pro Plug System (for use with minimum $\frac{5}{8}$ " thickness material)
- Simpson Strong-Tie Trim-Head Stainless Steel Screw
- GRK Fasteners FIN/Trim Finishing Trim Head Screws (ClimatekCoated or Pheinox Stainless Steel)
- Kreg Blue-Kote Pocket-Hole Screws (for assembling trim with pocket-holes).
- Weather resistant deck screws (for hidden fastening of crown mouldings, etc.)

Recommended Nails

- 8d nails with annular or spiral thread shanks (hot dipped galvanized or stainless steel)
- 15 ga. galvanized or stainless steel trim nails (decorative mouldings only e.g. crown moulding)

Trim Board Fastening Schedule	
Board Width	Fasteners/width 16" O.C. Max.
4"-6"	2
8"-10"	3
12"	4

Finishing

Screw and Plug Systems

When using this method for fastening trim, there is no need for additional filling of nail or screw holes. Once the plugs are set as (shown at right), the trim is ready for painting if desired.



Filling Nail Holes

- Dap® All Purpose Painters Putty®
- Sherwin Williams Shrink Free Spackling®
- Two-part Epoxy Putty

Painting

Cellular PVC trim does not require painting but, like any cellular PVC product, it will weather over time and painting will enhance these products to maintain color consistency for many years. Our cellular trim products are ready for painting and require very little preparation. Painting with a good quality, vinyl safe 100% Acrylic Latex paint will enhance these products to maintain color consistency for many years. There are several paint manufactures that will warranty their coating products on cellular PVC trim for 20 years or more. Our Warranty does not cover painted finishes or coating applied to the Product by the original purchaser or third party.

For white or light colors, we recommend a high quality 100% acrylic latex paint developed for TRIM. There are paint manufactures that sell coating specifically designed for PVC trim and mouldings. These paints are typically referred to as “vinyl safe” paints, or heat reflective coatings for vinyl. If you are going to paint the product a darker color, consult the paint manufacturer for the LRV (light reflective value).

Painting our cellular PVC product with paints darker than 56 to 0 (zero being Black) on the LRV scale voids any warranty. No priming is necessary, however the finish quality is greatly enhanced if you use a premium 100% acrylic latex paint for trim with a built in primer. In addition, a primer may be required under the paint manufacturer's warranty.

Always follow the paint manufacturer's instructions. In preparation for painting, we recommend product should be clean, dry and free of dirt, grease, and/or any other surface contaminants before painting. Adhesion can be improved by cleaning product with a mild detergent or denatured alcohol and using a soft clean rag or bristle brush.

Failure to adhere to manufacturer's recommended guidelines for application of painted surfaces may void any paint manufacturer's warranty.

Staining

Staining PVC mouldings takes a specialized base coat AWP SPQT Stainable Primer Wood Base Coat for Hard Surfaces. Follow the manufacturer's recommendations. Note that specialty applications such as this are not covered by our warranty.

Recommended Adhesives

G: Good Bond

Adhesive	PVC	Wood	Masonry	Steel
Extreme Adhesives PVC Trim Welder	G			G*
Quality Transparent PVC Cement	G			
Liquid Nails Subfloor Adhesive		G*		
Liquid Nails Heavy Duty Adhesive		G*	G*	
NPC Solar Seal 900		G*	G*	G*
Loctite PL Premium		G	G	G

* **Mechanical fasteners are always required.**

Helpful tip for gluing two pieces of PVC trim

Two Part Gluing Method: PVC adhesive along with Cyanoacrylate (super glue) and activator as a “clamp” can be used. However, Cyanoacrylate (super glue) is insufficient to use a They must be used in conjunction with PVC cement. (2P10 is only an example of a Cyanoacrylate/Activator system. There are others.)

Cyanoacrylate Glue
& Activator



PVC Cement

Using the two-part gluing system

- First, place a bead of PVC cement along one edge of one of the pieces to be glued.
- Next, place a similar bead of Cyanoacrylate glue.
- Spray the activator along the other piece to be glued. **Do not spray the coated face of the piece.**
- Carefully join the two pieces together making sure that they are aligned properly. Hold the pieces in place for 5-10 seconds or until the Cyanoacrylate glue adheres. This will allow for installation of the piece and give sufficient time for the PVC cement to create a permanent bond.

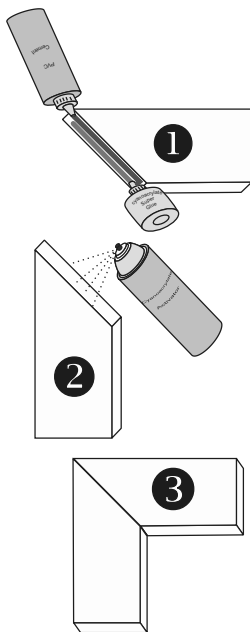

Heat Bending Trim

Cellular PVC is a thermoplastic polymer which means it becomes pliable or bendable when exposed to certain temperatures and returns to a solid state upon cooling. As such, some cellular PVC profiles can be reheated and reformed, or bent into new shapes. Variations in batches, profile geometry, and density or weight of the profile, will likely require some trialing and or experimentation to perfect this art and skill. For best results, do not bend any cellular PVC trim that is more than 6" wide. Some profiles are produced in a special formulation that facilitates bending; however, the capability to bend cellular PVC trim is limited—not all pieces can be successfully bent 100% of the time. Royal S4S Trim Boards are not recommended for bending. Precision Cut or SurEdge boards are preferred.

Methods for Bending Cellular PVC Profiles

There are several different methods that can be used to heat PVC profiles:

- Heat blankets - great for job site fabrications
- Convection air circulating ovens
- Radiant ovens or heaters
- Heat guns - great for small jobs and profiles

Whatever method is used, Westlake Royal Building Products assumes no liability, for any harm or damage to persons, product, or property related to heat bending. Any and all safety precautions to prevent any harm or hazard should be followed by the end-user.

Heat Bending using a Heat Blanket

Tool and Material Needs

- Heatcon HC99-300 Heat Forming Kit or equivalent
- Two 10' pieces of fiber cement siding
- Enough blocks of wood to raise the cement boards off the work table
- Heat resistant gloves
- Template of radius desired

How to:

- Place the two cement boards side by side on wooden blocks to protect the worktable from heat damage.
- Lay one heat blanket on each of the cement boards.
- Place the material to be heated on one of the heat blankets. **Make sure the "X" is facing toward the material to be shaped.**
- Lay the second heat blanket over the material.

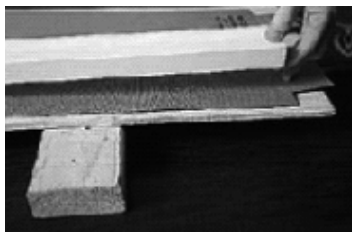
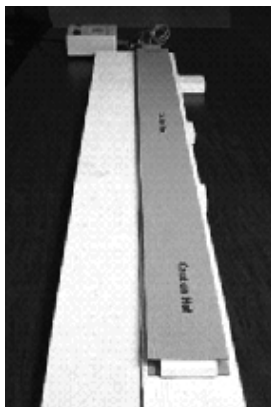
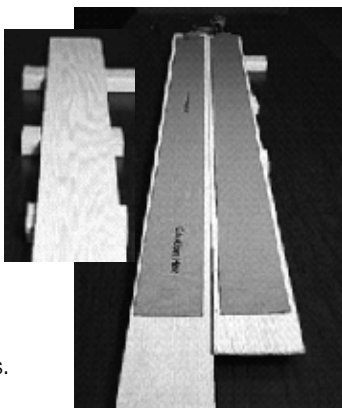

NOTE: The heating blankets must not touch each other. Place scrap pieces of trim between blankets if necessary.

- Lay the second piece of cement board on top of the blanket making sure the material doesn't shift.
- Making sure that the controller is not plugged into the wall, connect the heater power cords and thermocouples plugs on top of the HC7900 controller.

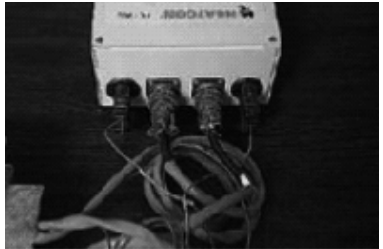
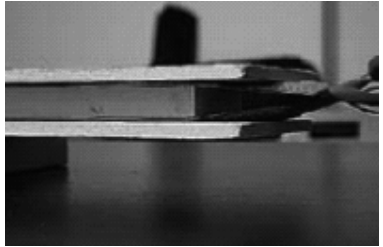

Set to PVC

- Plug the controller into the wall and push the on/off button. The display will flash the controller information and ask if you wish to bend PVC or decking.
- Use the left arrow to move the cursor to PVC and push the \checkmark key.

NOTE: Heating temperatures and times may vary depending upon material and profile.

Set Goal Temperature

- Using the up/down arrows, set the temperature at 275°F and push the ✓ key.



Set the time at temperature

- Using the up/down arrows, set the time for 8 minutes and push the ✓ key.



Now in "SET" mode

- You can change or edit the settings if desired by using the arrows.



Begin heating

- Push the ✓ key to begin the heat process.
- The controller will show "RUN."
- The timer LED will begin to blink.



End of the heating cycle

- The timer will sound an audible alarm when the heating cycle is complete.
- Push the \surd key to silence the alarm.

WARNING!

- **The heaters will remain on.**
- **The material will be hot and should only be handled using heat resistant gloves.**

Check consistency

- The material should feel like cooked spaghetti. If not, return to heating and continue checking every 2 minutes.

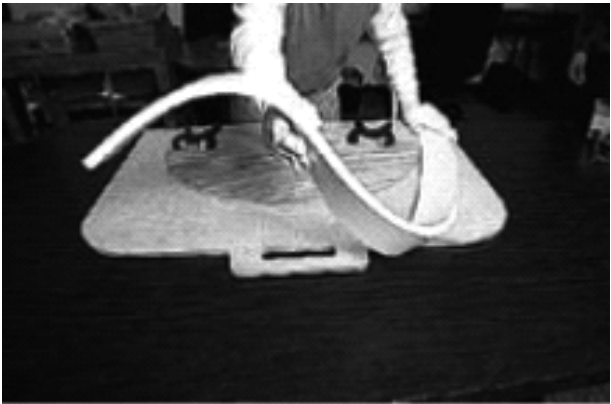
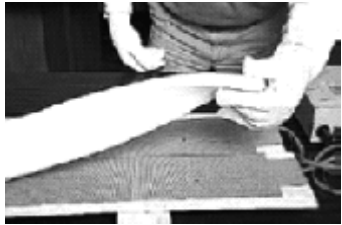

- Place one end of the softened material along the form.
- Clamp end to hold in place.

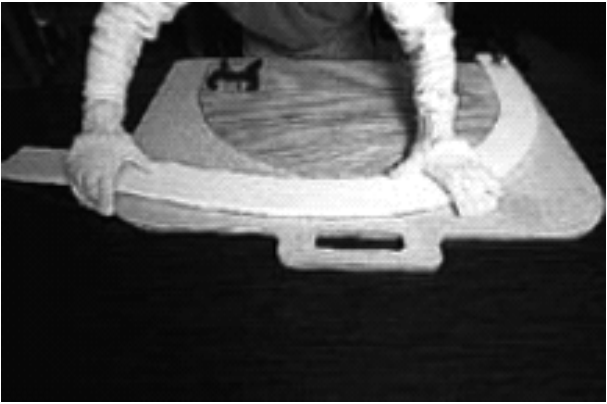

- Continue pulling the material gently along the form.
- If the material wrinkles or is too rigid to form, quickly re-straighten the material and return to heating.



- After completing the forming, place a clamp at the opposite end.
- Apply even pressure by running hands along material as it cools. **DO NOT APPLY TOO MUCH PRESSURE.**
- After material cools, remove it from clamps.

Water Tables

- Make sure that the wall is made weather resistant consistent with building codes. If no wrap is used, flash a minimum of 10" up from the bottom, hanging the flashing at least $\frac{1}{4}$ " over the bottom of the sill plate.
- Install the water table as shown below using weather resistant screws at 8-12" intervals.
- Install flashing at seams as shown.

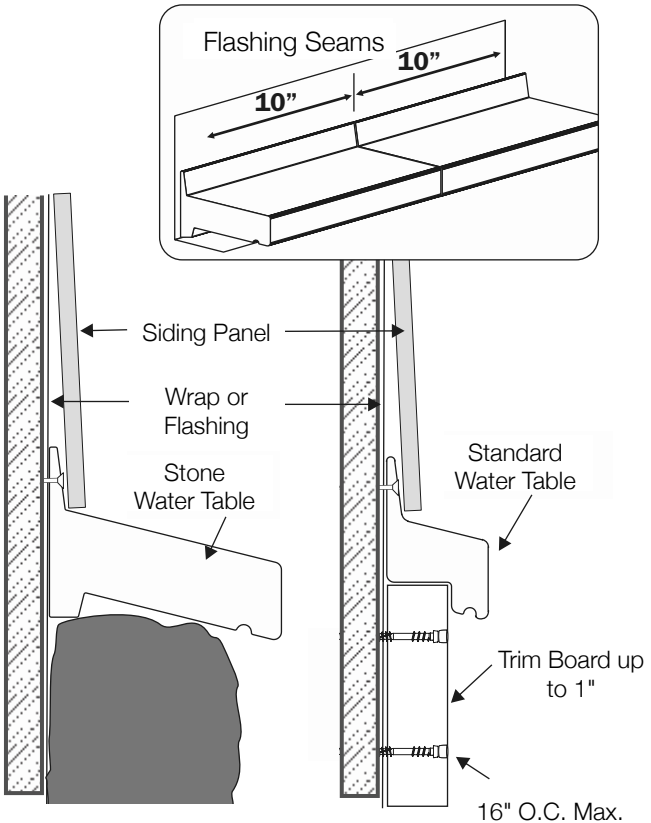

Skirtboard

- Make sure that the wall is made weather resistant consistent with building codes. If no wrap is used, flash a minimum of 10" up from the bottom, hanging the flashing at least $\frac{1}{4}$ " over the bottom of the sill plate.
- Install the skirt board as shown below securing it the same as a trim board (page 8)
- If a drip cap is used, glue the cap onto the board.

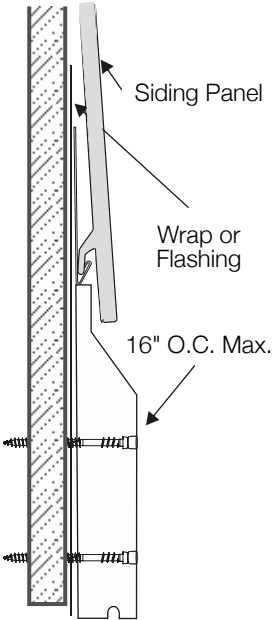

Conceal Skirt Board

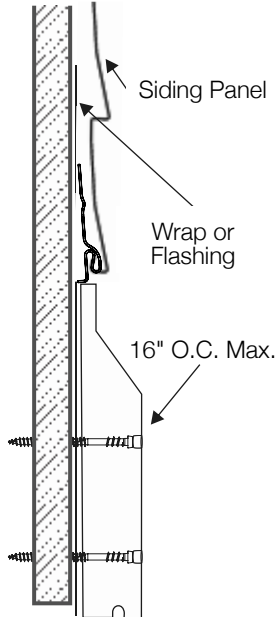

Conceal Skirt Board

Beaded, Shiplap, and Nickle Gap Planking for Soffit/Ceilings

Conceal Beaded, #2352 Beaded, Shiplap/Nickle Gap and flat sheet material can all be used for soffit and ceiling applications. It is however, very important to review the product specific guide lines below when choosing which products fits your application.

General Guidelines

- None of these products are to be used in load bearing applications.
- Extra framing may need to be added to support material beyond span limitations. 2X (1 1/2" thick) wood is recommend for the additional framing.
- If a seam is necessary within a 12' run, a shiplap is preferred to help conceal any shrinkage.
- Do not seam two panels directly to each other over 12'. Runs longer than 12' must either be full pieces (up to 16') or an expansion joint (rabbit or T-Mould) be used to allow for the expansion and contraction of the planking through temperature changes (pgs. 23, 24).
- Venting must be added to soffits where applicable. Check with local building codes for requirements.

#2352 3/8" Beaded Planking

- Span no more than 12" between fasteners.
- #2352 must also be glued to the framing/substrate.
- Only run #2352 perpendicular to the wall.

Conceal Beaded or Shiplap/Nickle Gap Planking

- Span no more than 12" between fasteners.
- No glue required when fastened with screws.
- Glue required when fastening with nails or staples.
- Should be run perpendicular to the structure whenever possible to result in the shortest pieces of material (pg. 23, figure1).

Beaded, Shiplap, and Nickle Gap Planking for Soffit/Ceilings cont.

Royal Trim Board Sheet Stock

3/8" thick sheet

- Not approved for soffit/ceiling applications.

1/2" thick sheet

- Span no more than 12" between fasteners.
- No glue required when fastened with screws.
- Glue required when fastening with nails or staples.

5/8" thick sheet

- Span no more than 16" between fasteners.
- No glue required when fastened with screws.
- Glue required when fastening with nails or staples.

*Maximum run before an expansion joint (shiplap or T-Mould) is 16' to allow for the expansion and contraction of the planking through temperature changes.

**Cortex or Proplug screws and plugs are approved for use with 5/8" or thicker material.

IMPORTANT: High Heat planking must be used in applications where there is potential for excessive heat build, such as porch ceilings with low pitches roofs that cannot be vented. In these applications, bead board must also be installed over a minimum of 1/2" substrate such as plywood or OSB.

Fastening

- Fasteners should penetrate 1 1/2" into substrate.
- Fasteners must be weather resistant such as stainless steel or hot dipped galvanized.
- Pneumatic guns can be used. Air pressure should be adjusted based upon gun, temperature, substrate, etc. (80-100psi typical).
- In cold weather below 40°, pre-drilling may be necessary.
- Staples can be used/16 gauge T-nail/15 gauge trim nail

Soffit/Ceiling Layout

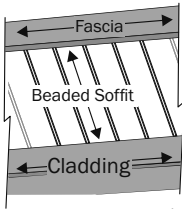

Fig. 1

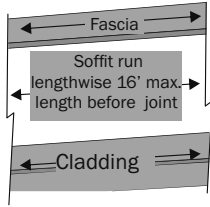

Fig. 2

* 2352 cannot be shiplapped. A T-Mould must be used.

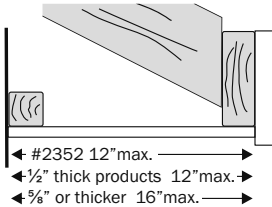

Fig. 3

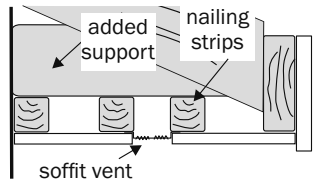

Fig. 4

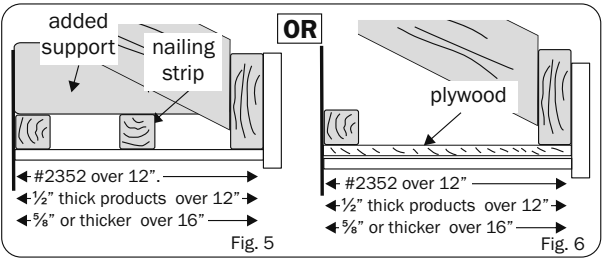
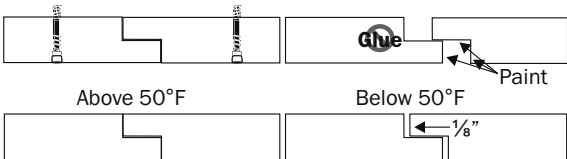

Fig. 5

Fig. 6

Shiplap Joints for long runs

Place a fastener 2" from the seam on both sides.



Soffit/Ceiling Layout cont.

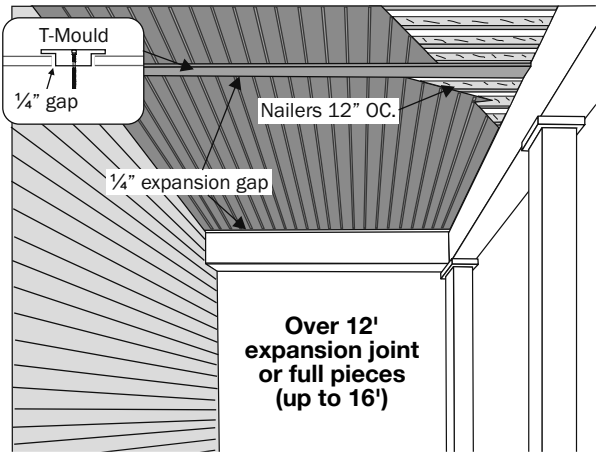
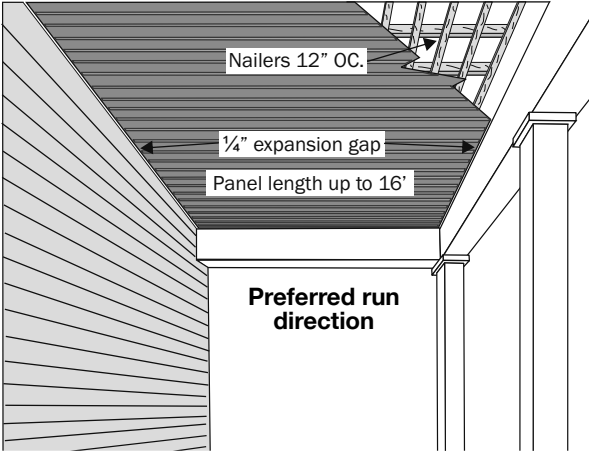

Beaded Planking for Wainscoting

- Cut pieces to the desired length. Square cut ends to ensure a 90° cut before beginning installation.
- Apply construction adhesive to the back of one piece of wainscot.
- Starting in a corner of the room and making sure the nailing fin faces away from the corner, press the first piece into place.
- Nail through the fin into the wall.
- Continue gluing and nailing until you come to the corner. At this point, it may be necessary to rip the last corner piece so that it will fit.
- Repeat along each wall.

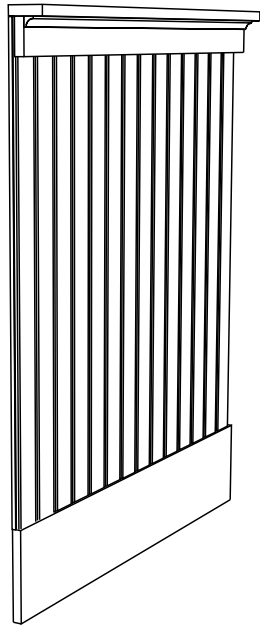
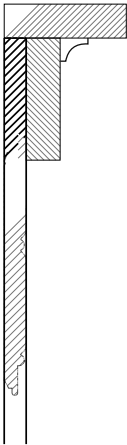

Frieze Boards, Band Boards, and Fascia

- Royal trim boards are not designed for structural use. Therefore, they must be supported. This includes fascia which must be fully supported by a sub-fascia.
- It is important to manage the expansion and contraction of longer runs using the methods described on page 23.
- Conceal trim can be used as frieze board by placing the board directly under the soffit material and securing it with fasteners as described on pages 8 and 9.
- Install siding as directed by the manufacturer.
- Always install head flashing above band boards to help manage any excessive water.
- Decorative crown mouldings, etc. should be fastened using 15 ga. galvanized or stainless steel trim nails.

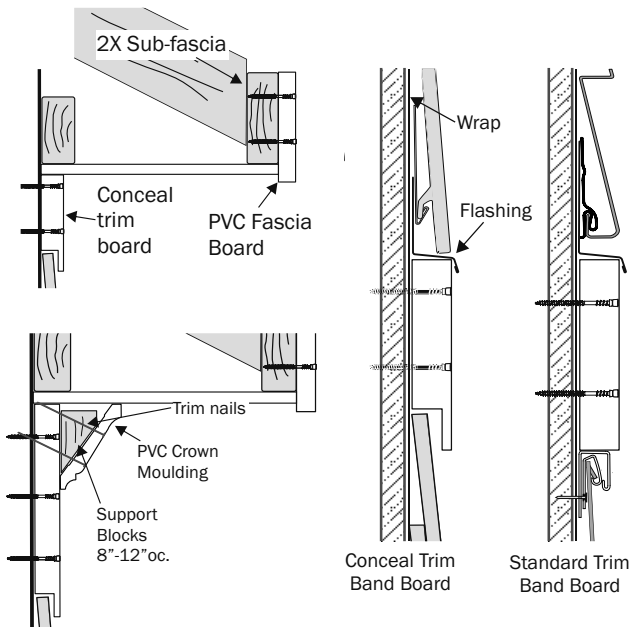

Managing expansion on longer runs

When joining boards in areas such as under eaves on fascia, a shiplap joint is recommended with the exception of at corners; a mitered corner will give the best appearance. Scarf joints are not recommended.

Scarf joints are not recommended.

Miters

When mitering a corner, the following rules apply:

- The trim board with a mitered end should be no longer than 4'
- Always glue the ends of the boards with PVC cement.
- Place a fastener 2" from the seam on both sides.

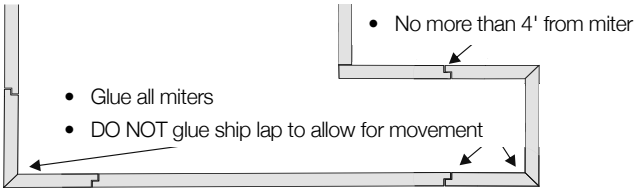
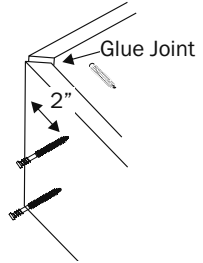

Place a fastener 2" from the seam on both sides

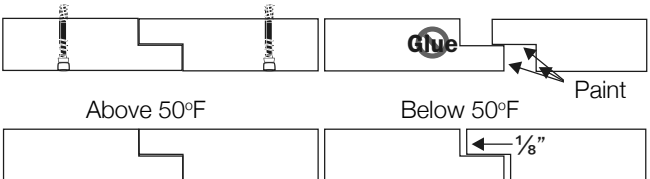

Gable Trim

The gable trim is a suitable alternative to a standard trim board if a small profile is desired.

- Measure from the soffit 1 1/4" and strike a chalk line.
- Install the panels aligning the ends with the line.
- Install the gable trim using Cortex or Pro Plug screws and matching plugs. Place fasteners approximately every 12"-16".

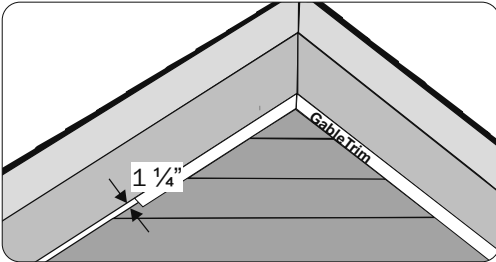

Cutting Miters on Gable Trim

The multiple angles designed into the finish trim and the gable trim allow for the adjustment of the pocket width desired depending upon the application. However, if the installation includes mitering two adjacent pieces of trim together such as at the peak of a gable, it is important that the trim be placed correctly when cutting as shown in figure 9. A scrap piece of 3/4" thick material can be used as a guide to making placement easier.

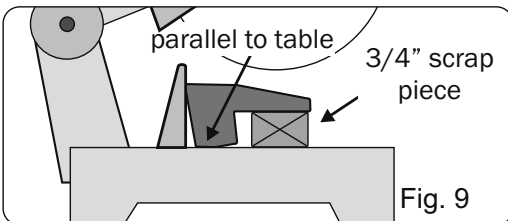

Corners

Conceal Corner Board

- Outside corner areas should be made weather resistant in accordance with building codes, typically using flashing material or house wrap.
- Install the corner board leaving 1/8" gap between the corner and any eve.
- Extend corner 1/4" minimum below sheathing.
- Fasten as described on page 8.
- Install siding in accordance with manufacturers instructions.

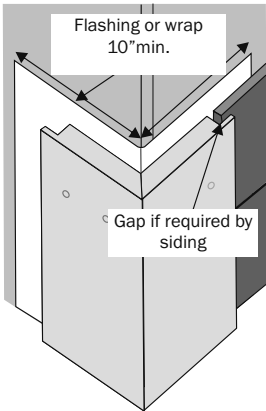

Rabbeted Corner

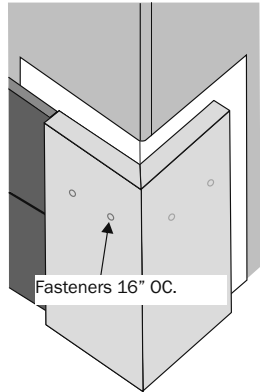

Traditional Square Corner

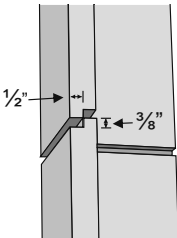

- If more than one length of corner is required, create a rabbet joint.
- To allow for expansion and contraction thru temperature changes, do NOT glue this joint.
- Paint the inside of the rabbet as necessary.

Inside Corners

- Inside corner areas should be made weather resistant in accordance with building codes, typically using flashing material or house wrap.
- Install the corner board leaving 1/8" gap between the corner and any eve.
- Extend corner 1/4" minimum below sheathing.
- Fasten as described on page 8.
- Install siding in accordance with manufacturers instructions.

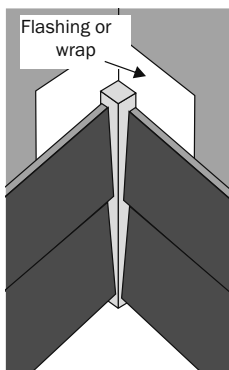

Inside Corners made with Conceal Boards

- Rip one side down by 1" in width.
- Run a bead of PVC cement to glue to two pieces together.
- Assemble the corner before installing on the wall using screws to attach the two boards together (1). Place fasteners every 12"-16" staying 2" from the ends of the boards.
- Install and fasten to the wall as outlined on page 8 (2).
- If more than one length of corner is required, create a rabbet joint.
- To allow for expansion and contraction thru temperature changes, do NOT glue this joint.
- Paint the inside of the rabbet as necessary.

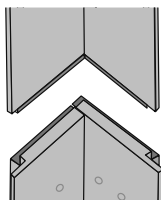
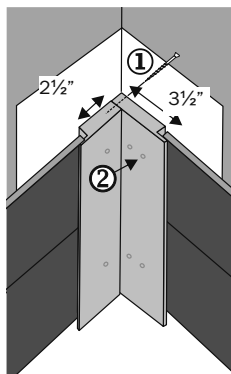

Basic Rules to Assembling Window Frames

- Make certain that the window is properly flashed in accordance with local building code requirements. PVC trim is intended to be aesthetic and not part of the water resistant system.
- It is recommended that the window frame be assembled prior to the installation around the window. Joints should be glued and screwed together. Pocket screws should be used where possible.
- Measure the width and height of the window. Add 1/8" to both measurements. This will leave 1/16" spacing around the perimeter of the window to allow for expansion and contraction of the frame.
- Fasten the frame to the wall using fasteners outlined on page 8.

Picture Faming

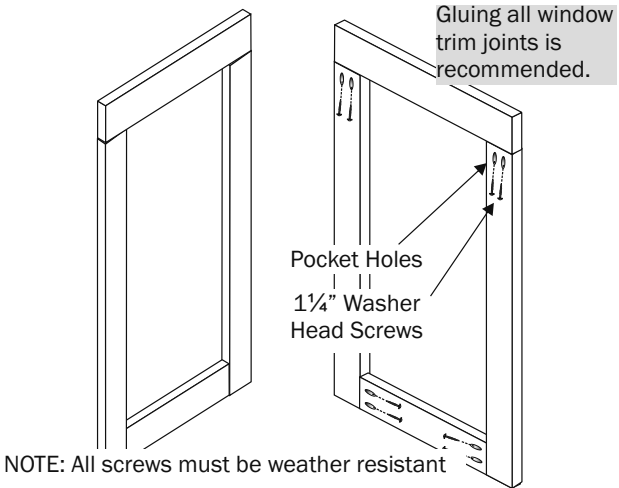

Adding Crown and Sill Nose

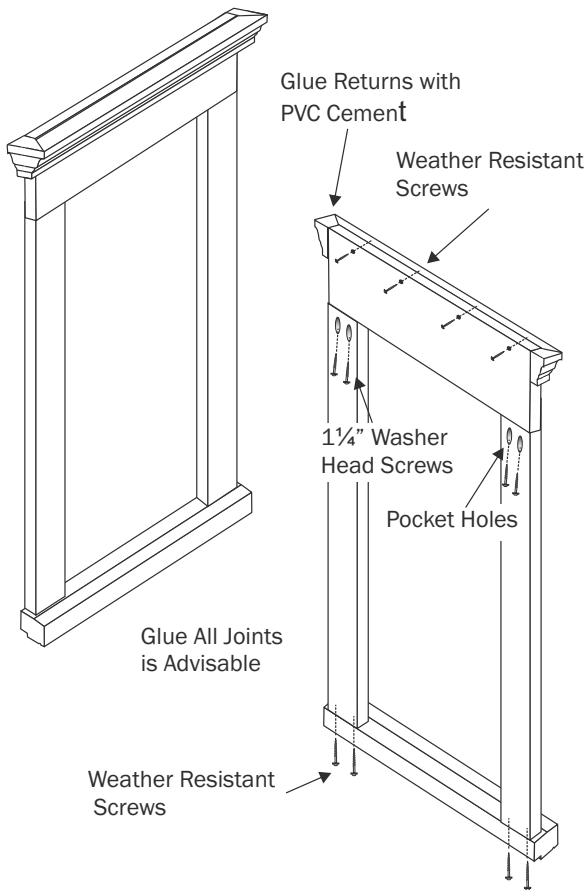

Inside Backband

- Run a bead of PVC cement along side edge of window trim.
- Install backband and fasten using the fasteners outlined on page 8.

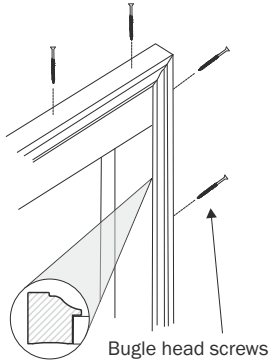

Installing an Apron

- Begin by fastening the apron to the jamb trim. (It is typical to use a wider board for the apron to result in a similar apron reveal below the sill nose.)
- Run a bead of PVC cement on apron where sill will be placed.
- Next, install the sill nose with screws as shown.

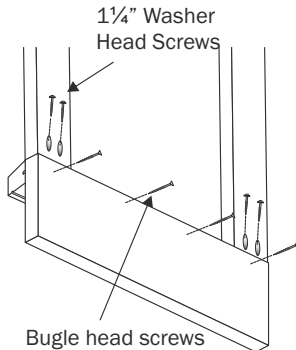

Conceal Window Trim Assembly

Shown are three methods for assembling Conceal trim around windows. The same basic rules outlined on page 21 apply.

- Make sure to leave 1/16" space on all four sides of the window for expansion and contraction of the trim.
- It is suggested that the trim frames can be assembled prior to the installing on the wall.
- When mitering corners, it is recommended that cement be used.
- When square cutting joints, remove pieces as shown to create a continuous channel.
- When securing frame to the wall, fasteners must not penetrate through the siding pocket.
- Fasten the frame using the fasteners outlined on page 8.
- Install head flashing inside the pocket of the header trim.

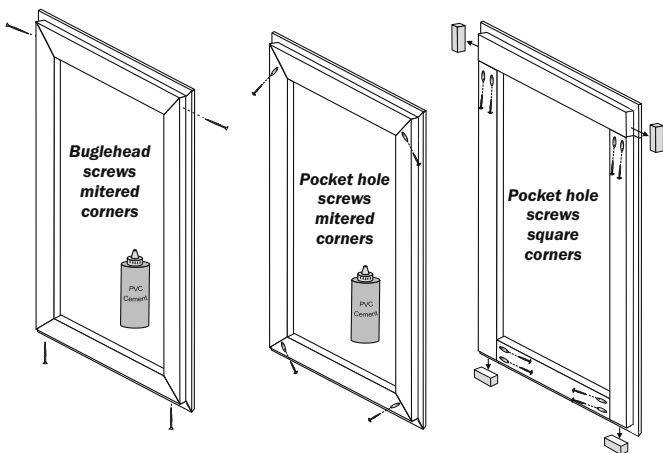

New Construction Window Surround

New Construction Window Surround can be used in many areas for trim but is particularly useful around windows with a nailing flange (Figure 1.). *It is recommended that the window surround be assembled prior to its application around the window. When measuring for the surround, measure to leave a 1/16" space between the surround and the window on all sides to allow for expansion and contraction of the trim thru temperature changes.*

- Window trim should be fastened to the wall using fasteners outlined on page 8.
- Install head flashing inside the pocket of the header trim.

Squared Off Corners

- Remove any material necessary to allow the Channel to continue completely around the window (Figure 2.).
- Use the integrated pocket on the back of the trim to secure the corners using weather resistant screws (Figure 2.).

Mitered Corners

- Miter and assemble as shown in Figure 3 using weather resistant screws.

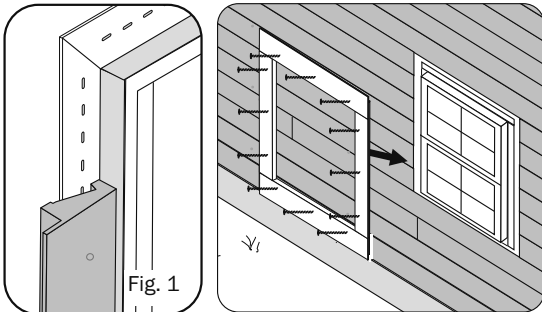

Squared Off Corners

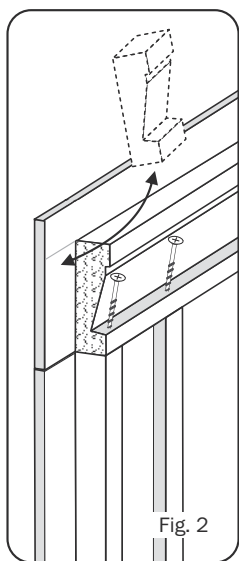

Mitered Corners

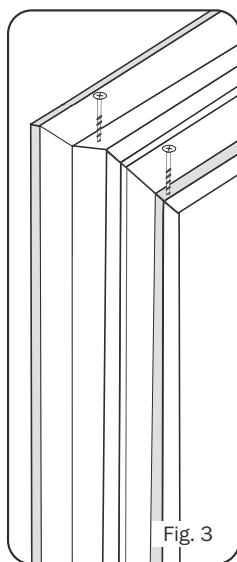

Garage Door Stop

- Install the jamb pieces first, then the header.
- Position the stop so the weather strip is in contact with the garage door. The inside of the stop's base will be approximately 1/2" from the garage door.
- Fasten the stop in place with color coordinated galvanized or stainless steel trim nails in the pre-punched holes or at approximately 8" intervals.
- Trim the weather stripping on the header piece to create a mitered look and help keep a continuous seal.

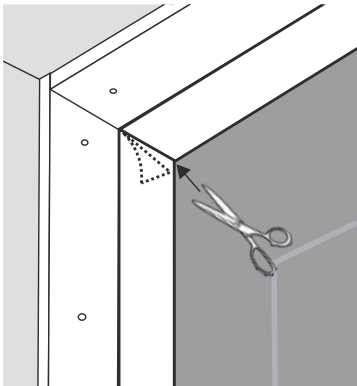
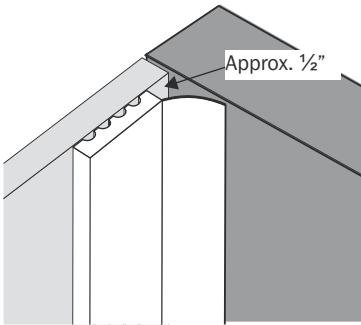

Columns Wraps

Tools and Supplies

- Circular saw
- Level
- Hammer
- Pencil
- Drill/Driver and appropriate bits
- 2 Bar/quick clamps
- Square
- Tape Measure
- Clear PVC glue
- 3" weather resistant screws
- Cortex or equivalent screws and PVC plugs

Installation

- Begin by measuring the height of the existing column and cut column wrap to length.



NOTE: Shim inside wrap if necessary to achieve snug fit to existing column. This will allow for proper securing of the wrap.

Tip: It is easier to cut the column wrap to length prior to removing all the shrink wrap.

- Place the three sided section of the wrap around the column. Make certain that the wrap is as plumb as possible (shims may be necessary). Secure the wrap to the column placing a weather resistant screw at the top and at the bottom of the column. Place the screws so they will be hidden by the cap and base. If no caps or bases are going to be added, two screws at both the top and bottom should be installed. Cortex or equivalent screws and PVC plugs can be used to achieve a finished look. In this case, use at least two screws at both the top and the bottom of the column.



- With the remaining wrap side laying on a flat surface, run a small bead of clear PVC cement completely along both joint edges.



- Begin the installation of the remaining side using a bar clamp at the bottom to hold it in place. Using a second bar clamp, start at the bottom and work up, drawing the joint along one mitered edge together, clamping and releasing as you go, and making sure the joint is fully engaged. Repeat this process along the other mitered edge and secure the side with screws at the top and bottom.



Tip: Once the final side is locked in place, use a sanding block with fine 320 grit or more sand paper to lightly sand or burnish the miter joint. This will smooth out any sharp or rough edges.

Caps and Bases

- Caps and bases are installed in the same manner as the column wrap.
- Pre-assemble the capitals and bases around the column as shown below before securing them. This will allow for any minor adjustments that may be needed.
- For a finished look it is recommended that a screw and PVC plug system such as Fasten Master Cortex or Starborn Pro plugs be used.

Tip: If needed, use exterior grade caulking to cover any gaps.

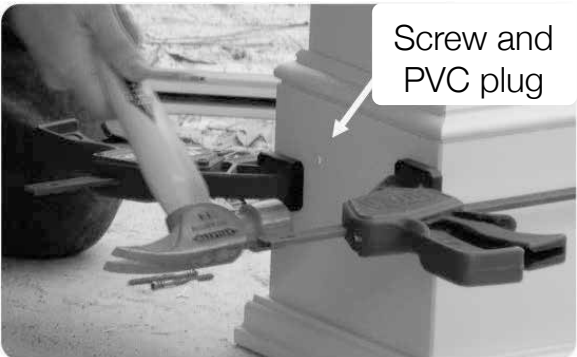
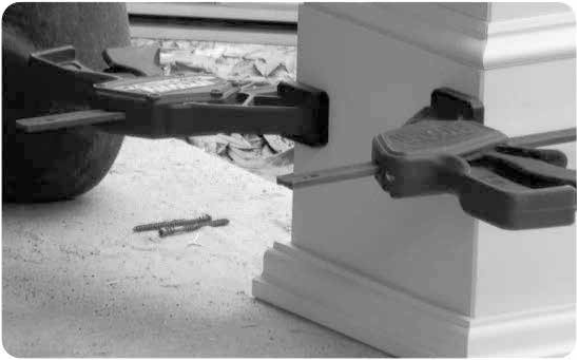

Cleaning

Cleaning Royal products is easy and fast with most major household cleaners. There are many cleaners on the market and the glass cleaners seem to be the best candidate for keeping the finish intact. The cleaning solution should be applied and immediately wiped dry. With any cleaning material, the cleaning solution should not be left to stand on the components for an extended period of time. Royal recommends the following cleaners:

- Windex®
- 409 Glass and Surface Cleaner®
- Spic & Span Cinch®
- Fantastik All-Purpose®
- Fantastik Orange Action®
- Regency® (Glass and Surface)
- Clorox Clean-Up®
- Glass Plus®
- Fantastik Oxy Power Multi-Purpose Cleaner®

What to Avoid

Harsh cleaners with glycol ethers or ethanol type solvents and/or isopropyl alcohol soften the coating if left on for several minutes and are not recommended.

Examples of these harmful cleaners are:

- Goof Off®
- Wal-Mart "Great Value All Purpose Cleaner®" (glycol ether)
- 409 General Purpose® (2-Butoxyethanol)
- Greased Lightning® (glycol ether)
- Citrus cleaners
- Abrasive cleaners
- Solvents such as acetone, paint remover, and lacquer

Frequently Asked Questions

How do I clean and remove scratches?

If the scratches are not too deep, you can use Windex and Mr. Clean MAGIC ERASER, (or Scotch-Brite® Non-Scratch Scrub Sponge). Apply the cleaner. Use the eraser or sponge, and rub in circular and up and down motions, until scratches are buffed out. This takes some time, depending on the severity of the scratches. You can also use Turtle Wax® Rubbing Compound to remove surface scratches. Clean the product after buffing out the scratches.

There are many cleaners on the market that will work for cleaning PVC:

- Windex®
- 409 Glass and Surface Cleaner®
- Spic & Span Cinch®
- Fantastik All-Purpose®
- Fantastik Orange Action®
- Regency® (Glass and Surface)
- Clorox Clean-Up®
- Glass Plus®
- Fantastik Oxy Power Multi-Purpose Cleaner®
- DeckMAX®
- M1 House Wash®
- LA's Totally Awesome® All-Purpose Cleaner

Does cellular PVC trim and/or cellular PVC require painting?

No. Cellular PVC trim does not require painting but, like any cellular PVC product, it will weather over time and painting will enhance these beautiful products to maintain color consistency for many years. Our cellular trim products are ready for painting and require very little preparation. Painting with a good quality, vinyl safe, 100% acrylic latex paint will enhance these beautiful products to maintain color consistency for many years. There are several paint manufacturers that will warranty their coating products on cellular PVC trim for 20 years or more. Our warranty does not cover painted finishes or coating applied to the product by the original purchaser or any third party.

If I do paint, what type of paint should I use?

For white or light colors, we recommend a high quality 100% acrylic latex paint developed for trim. There are paint manufacturers that sell coatings specifically designed for PVC trim and mouldings. These paints are typically referred to as “vinyl safe” paints, or heat reflective coatings for vinyl. If you are going to paint the product a darker color, consult the paint manufacturer for the LRV (light reflective value). Painting our cellular PVC product with paints darker than 56 to 0 (zero being black) on the LRV scale voids warranty.

No priming is necessary; however, the finish quality is greatly enhanced if you use a premium 100% acrylic latex paint for trim with a built in primer. In addition, a primer may be required under the paint manufacturer's warranty. Always follow the paint manufacturer's instructions. In preparation for painting, we recommend product should be clean, dry, and free of dirt, grease, and/or any other surface contaminants before painting. Adhesion can be improved, and product should be cleaned with a mild detergent or denatured alcohol and soft, clean rag or bristle brush. Failure to adhere to manufacturer's recommended guidelines for application of painted surfaces may void any paint manufacturer's warranty.

Can you stain PVC mouldings?

Yes, but staining PVC mouldings takes a specialized base coat AWP SPQT Stainable Primer Wood Base Coat for Hard Surfaces. Follow the manufacturer's recommendations. Note that specialty applications such as this are not covered by our warranty.

Can PVC be used as a structural component such as framing?

PVC cannot be used as a structural product in load bearing applications. PVC boards must always be supported by wood or other structural materials.

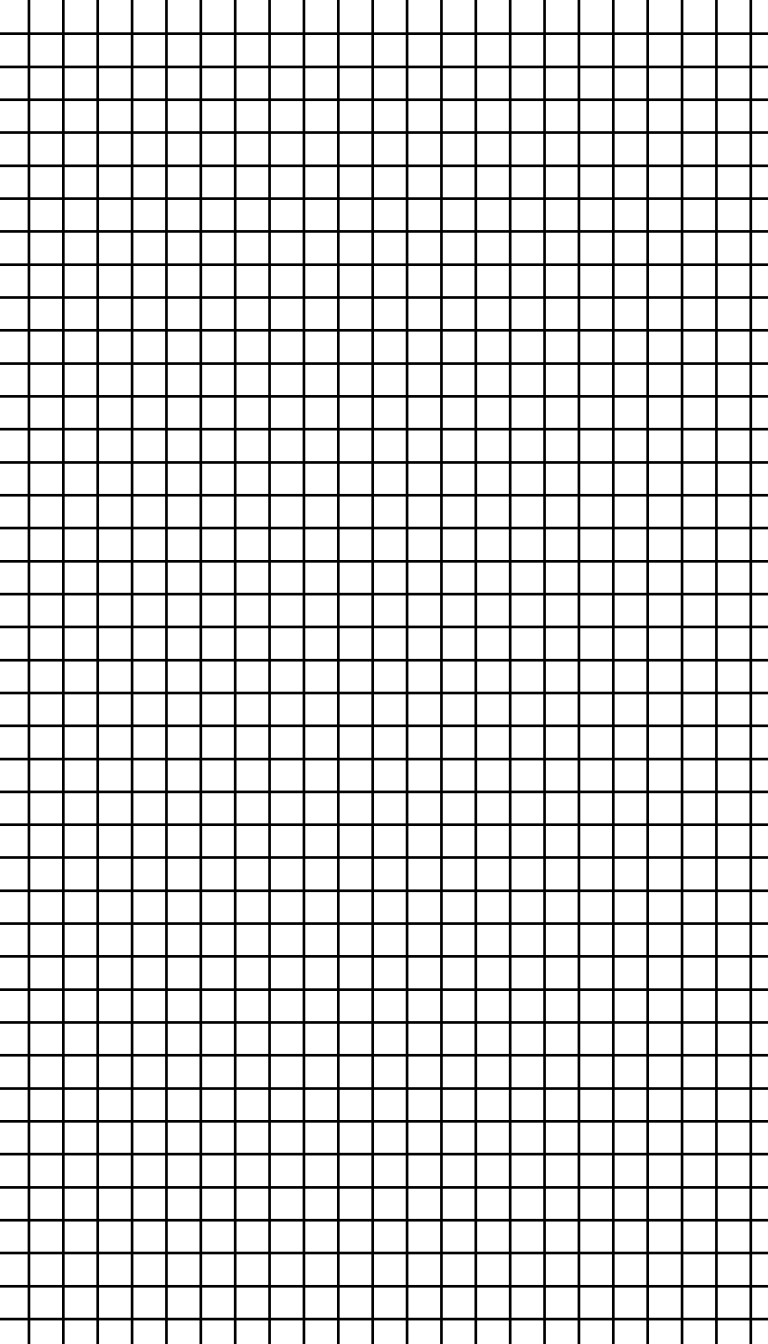

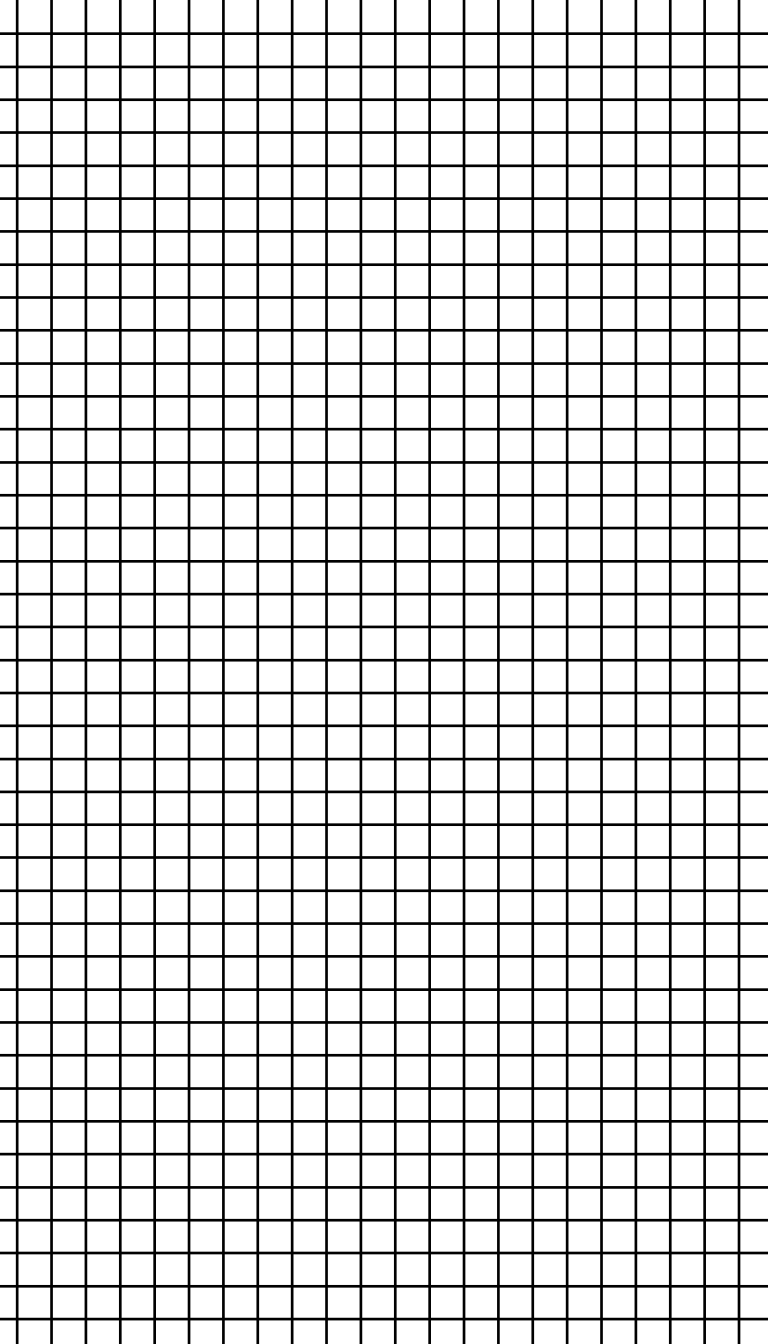



BOUNDLESS™

Giving everyone the products, tools and technology to transform spaces into anything they want.



SIDING & ACCESSORIES

TRIM & MOULDINGS

ROOFING

STONE

WINDOWS

OUTDOOR LIVING

Westlake
Royal Building Products™

© 2023 Westlake Royal Building Products

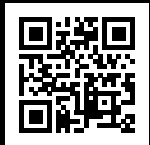

Royal® Trim & Mouldings
RoyalTrimMoulding.com | 855-769-258
Item # 96888 | RTM97250 2/23