

## CASING

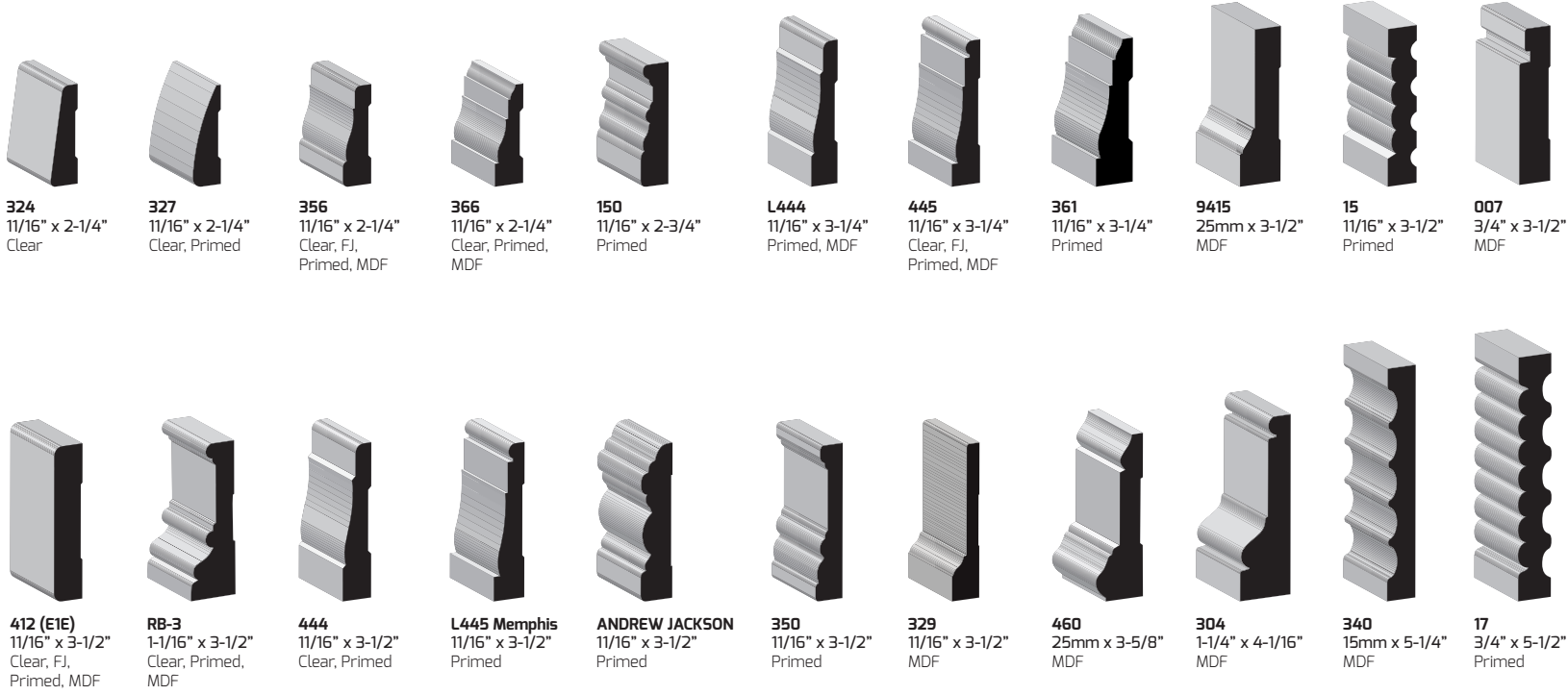

## CORNER

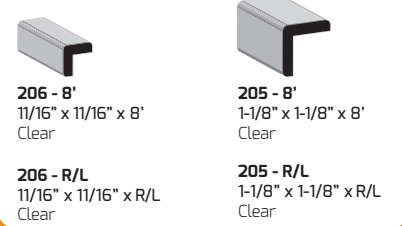

## SILL

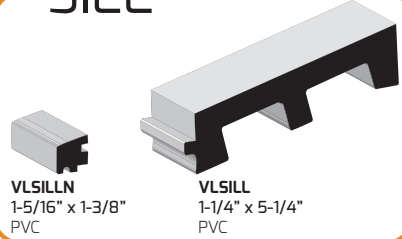

## SCREEN



## CHAIR RAIL

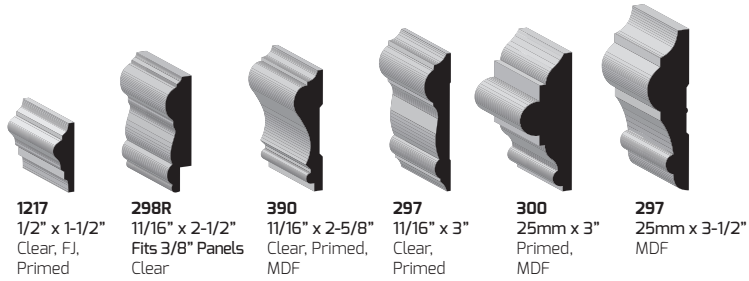

## LANDING TREAD



## COVE

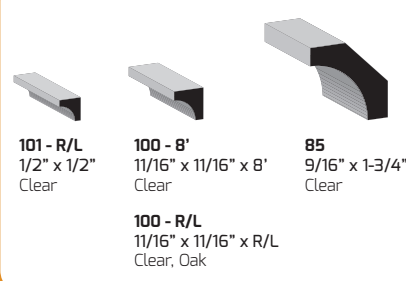

## HAND RAIL

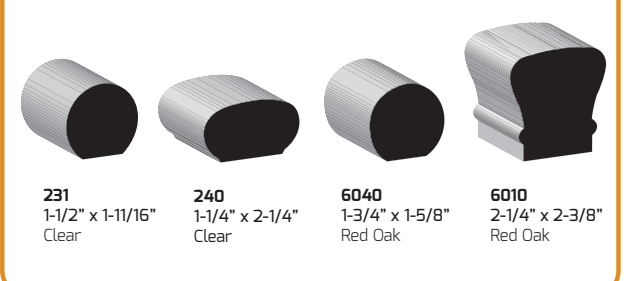

## CROWN/BED



\*IMAGES REPRESENT STANDARD PROFILES. ACTUAL PROFILES MAY VARY SLIGHTLY.\*

## BASE

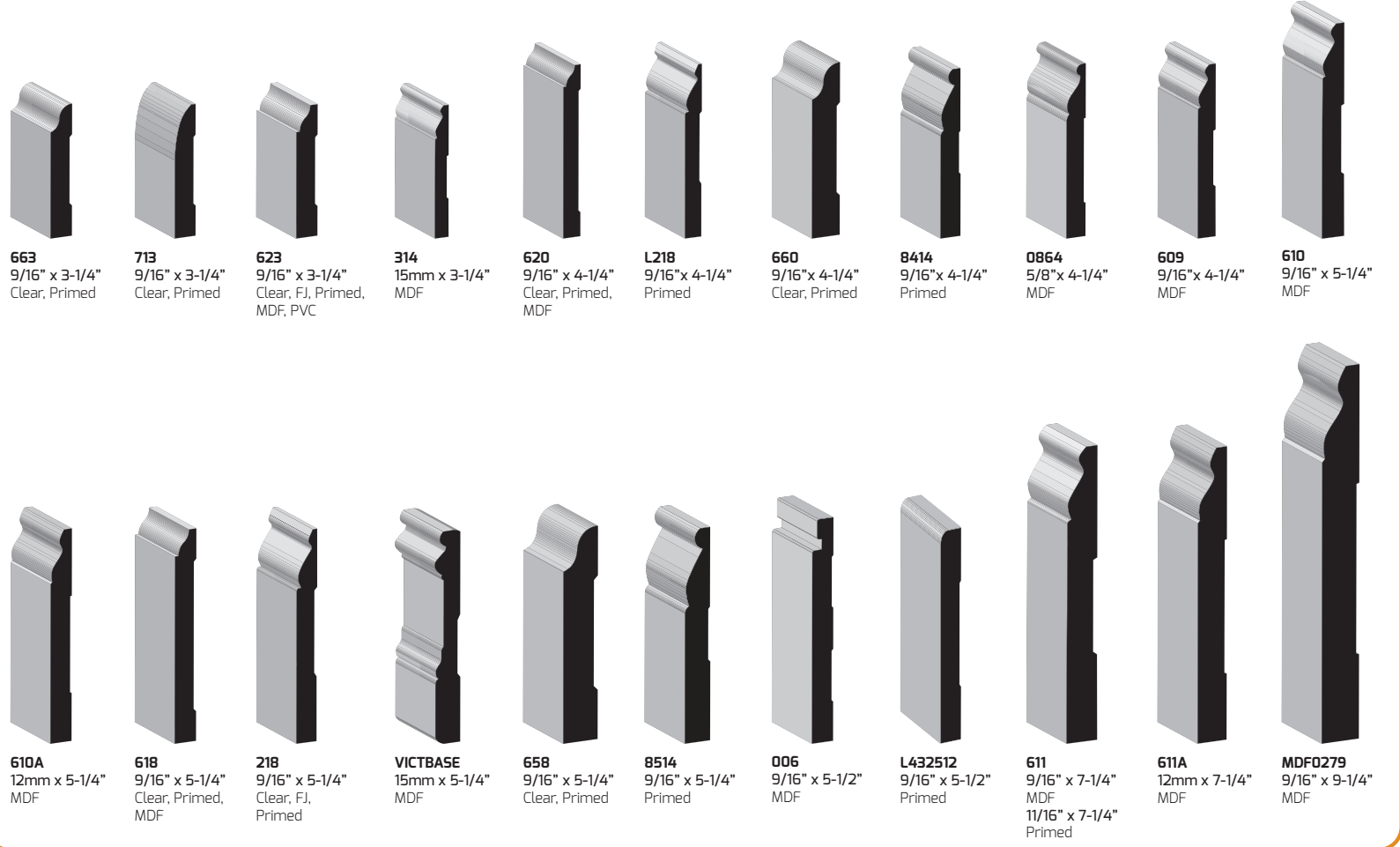

## PANEL/CAP

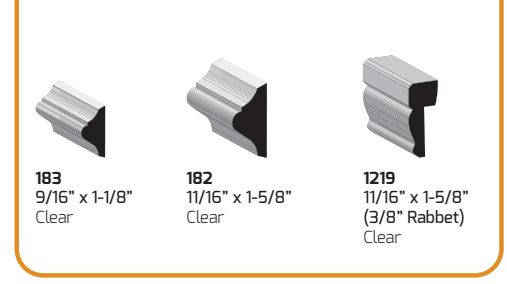

## BACK BAND

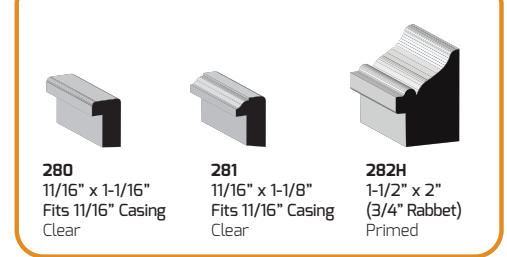

## APRON

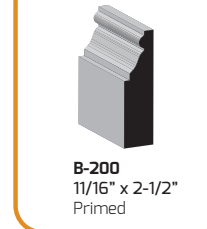

## BRICK MOULD

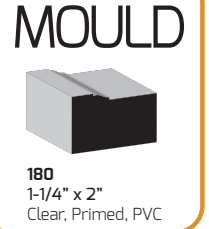

## CHAIR RAIL BACKER

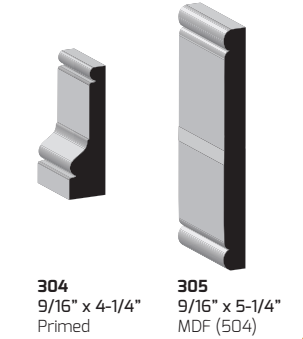

## S4S BOARDS /S4S STOCK

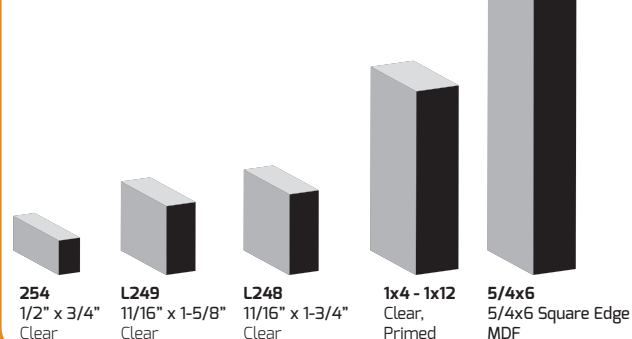

## CRAFTMAN HEADER



## ROUNDS



## MULLION

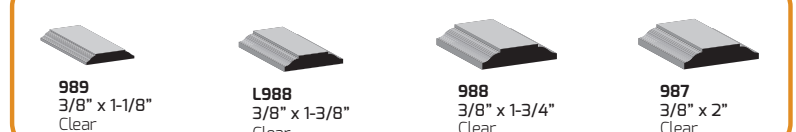

## STOP

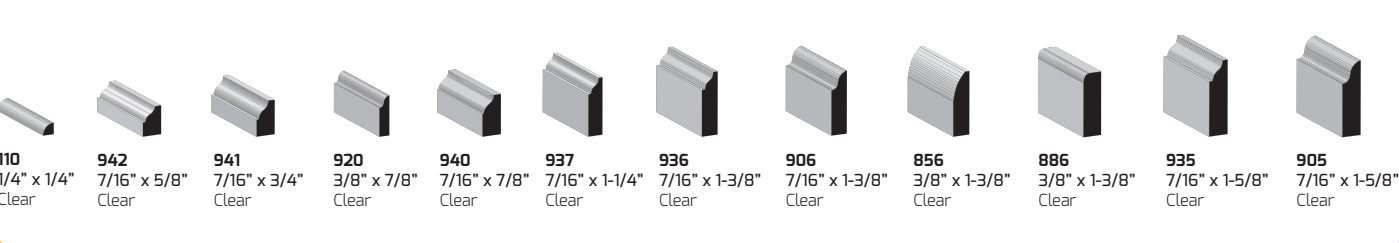

## BASE CAP

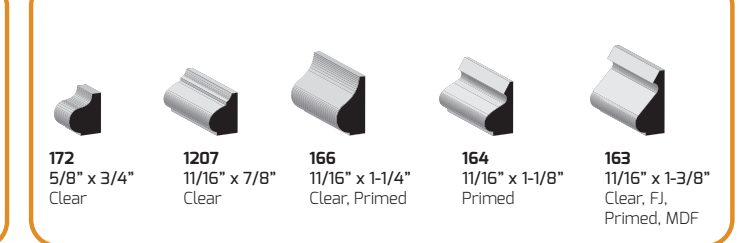

## JAMBS

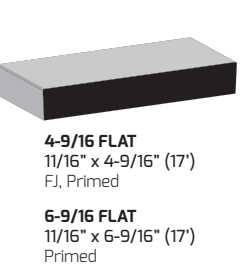

## LATTICE

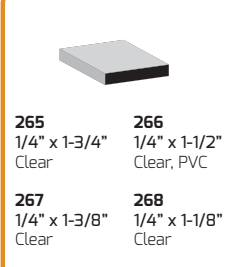

## DRIP CAP

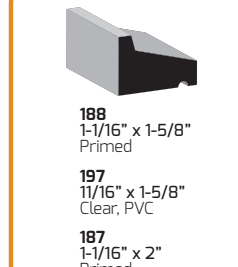

## STOOL

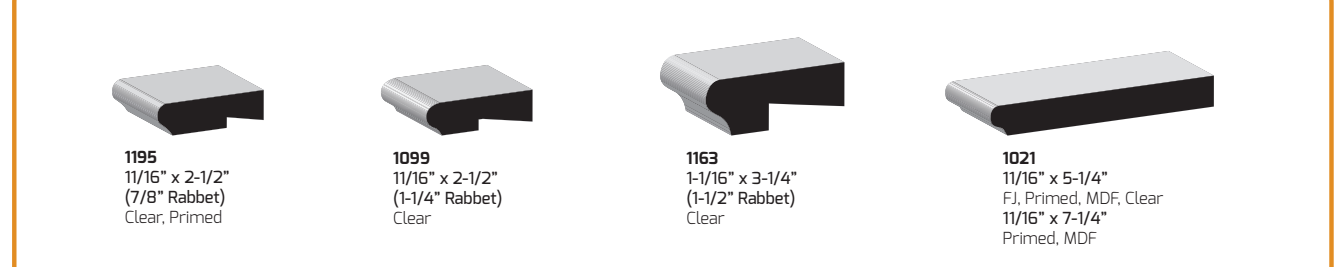

## PICTURE MOULD

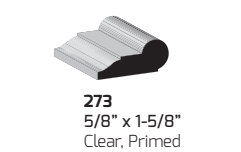

## SHOE

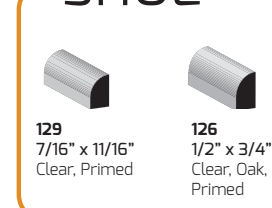

## JOINT MOULD



## CHAMFER



## SHINGLE

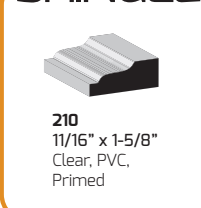

## PLYCAP

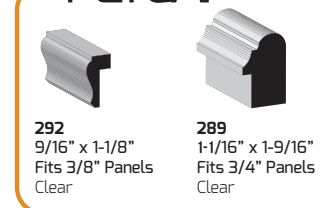

## GLASS BEAD

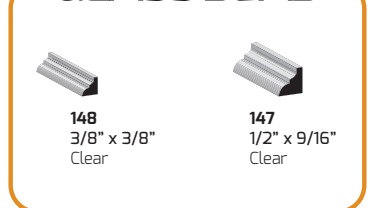

\*IMAGES REPRESENT STANDARD PROFILES. ACTUAL PROFILES MAY VARY SLIGHTLY.\*