

CEILING & WALL GUIDE

Armstrong[®]
CEILING



TOOLS YOU CAN USE

WEBSITE: ceilings.com

WEB TOOLS:  **Commercial Access Program**
ceilings.com/dealertools

 **Ceiling Project Estimator**
ceilings.com/projectestimator

 **Drop Ceiling Calculator**
ceilings.com/calculator

 **Ceiling Replacement Finder**
ceilings.com/IDMyCeiling

INSPIRATION: **Photo Gallery**
ceilings.com/photos

Look Book
ceilings.com/lookbook

Getting Started Videos
ceilings.com/videos

**INSTALLATION
AND VIDEOS:** ceilings.com/installation

 ceilings.com/videos

WARRANTIES: ceilings.com/warranty or contact
techline@armstrongceilings.com

TECHLINE: 1-877-ARMSTRONG (276-7876)
techline@armstrongceilings.com



1276 WOODHAVEN™ DRIFTWOOD GRAY (CEILING)

TABLE OF CONTENTS

Getting Started

Wood Look—Surface Mount (Direct Apply) Ceilings

Wood Look—Walls

Tin/Metal—Suspended (Drop) or
Surface Mount (Direct Apply) Ceilings

Tin/Metal—Walls

PVC Plastic—Suspended (Drop) Ceilings

Decorative Look—Suspended (Drop) Ceilings

Smooth Look—Suspended (Drop) Ceilings

Textured Look—Suspended (Drop) Ceilings

12-in x 12-in—Surface Mount (Direct Apply) Ceilings

24-in x 48-in—Surface Mount (Direct Apply) Ceilings

Commercial Access Program

Installation—Suspended (Drop) Ceilings

Fire Safety Information

Installation—Drywall Grid Products

Installation—Surface Mount (Direct Apply) Ceilings

Installation—WoodHaven™ Planks
Surface Mount (Direct Apply) Ceilings



Product Comparison Data

Performance and Installation Method Guide by Item

Packaging Guide by Item

GETTING STARTED WITH CEILINGS

1 HOW IT INSTALLS

| Attachment Method | Benefits | Installation Method | Sizes Available |
|------------------------------|---|--|--|
| Suspended (Drop) |  Get access behind panels | Metal grid system and hanging hardware | 24-in x 24-in 24-in x 48-in |
| Surface Mount (Direct Apply) |  Maximize ceiling height | Easy Up® Installation System (12 x 12 tiles, 6 x 48 and 5 x 84 planks); All-in-one Self-stop Fastener or Truss Mounting Kit (24 x 48 AcoustAffix® panels); or Adhesive (12 x 12 tiles, 6 x 48 planks, 24 x 48 AcoustAffix® panels) | 12-in x 12-in 6-in x 48-in 5-in x 84-in 24-in x 48-in |

2 CHOOSE A LOOK

DESIGNER



SUSPENDED (DROP) CEILINGS

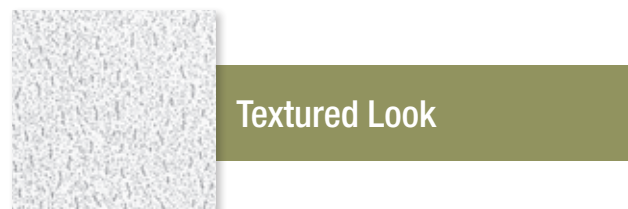
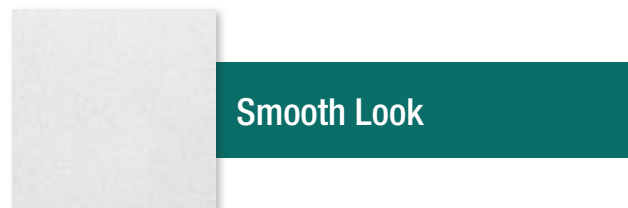

SURFACE MOUNT (DIRECT APPLY) CEILINGS

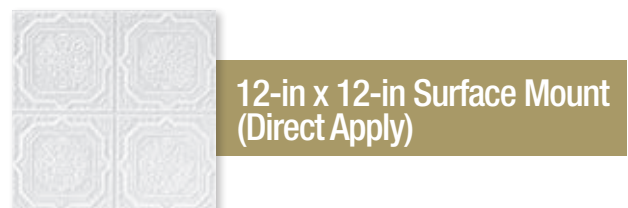

Edge detail impacts overall look



tongue & groove



square edge



regular edge

3 CONSIDER PERFORMANCE FEATURES



Sag/Humidity Resistance: Products with this icon have superior performance and maintain a flat, attractive ceiling surface in areas of up to 90% humidity; use in spaces that are not climate controlled

Standard Performance: appropriate for climate controlled spaces

Superior Performance: appropriate for non-climate controlled interior spaces



Noise Reducing: Products with this icon reduce noise within a room or traveling from room to room

NRC: reduces noise within a room, the higher the number, the better the performance

CAC: blocks sound between rooms, the higher the number, the better the performance



Mold/Mildew Resistance: Products with this icon have superior performance and resist the growth of mold and mildew on the treated surface

Standard Performance: appropriate for climate controlled spaces

Superior Performance: appropriate for non-climate controlled interior spaces



Fire Resistance: Products with this icon meet building codes for commercial and residential spaces, based on E-84 testing

All ceiling products meet or exceed residential fire or safety codes.

DISINFECTABILITY AND CLEANABILITY



Disinfect by Fogging: Products with this icon may be fogged following CDC recommendations using EPA-approved disinfectant cleaners per Armstrong Disinfecting Guidelines.



Disinfect by Wiping: Products with this icon may be wiped following CDC recommendations using EPA disinfectant cleaners per Armstrong Disinfecting Guidelines.



Disinfect by Spraying: Products with this icon may be sprayed following CDC recommendations using EPA disinfectant cleaners per Armstrong Disinfecting Guidelines.



Cleanable: The majority of Armstrong® Ceiling and Grid products can be cleaned using one or more methods*.

NOTE: See *Disinfecting Guidelines* on ceilings.com/cleanmyceiling for recommended disinfecting methods and disinfectants.
* *General Cleaning Guidelines* for most products, including recommended cleaning methods and cleaners, are also available on ceilings.com/cleanmyceiling



1149 WOODHAVEN™ BEADBOARD (CEILING)

WoodHaven™
CEILING & WALL PLANKS



WOODHAVEN™ CEILING PLANKS

Our 5-in x 84-in WoodHaven™ ceiling planks offer a range of finishes for every room, are made of MDF (medium density fiberboard) and can be installed in three different ways.

CEILING FINISHES



1140 CLASSIC WHITE

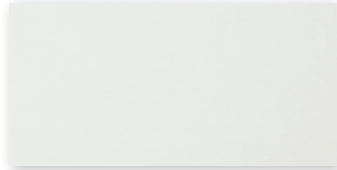

1148 PAINTED WHITE



1149 BEADBOARD



1138 WOVEN WHITE

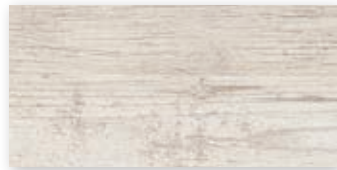

1275 COASTAL WHITE



1276 DRIFTWOOD GRAY



1139 WOVEN CHARCOAL GRAY



1273 WEATHERED



1265 WHITE WASH

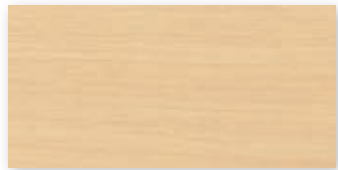

1261 NATURAL MAPLE



1262 CLASSIC MAPLE

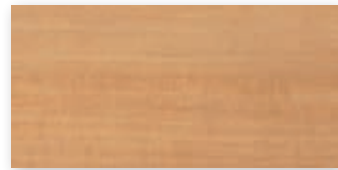

1263 NEW APPLE



1271 BAMBOO

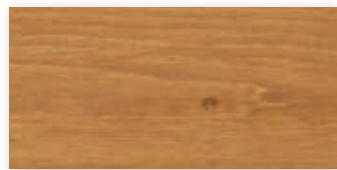

1260 KNOTTY PINE

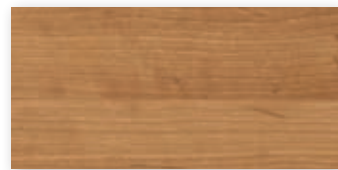

1268 NATURAL CHERRY













1264 RUSTIC PINE

FEATURES & BENEFITS

- Prefinished; no sanding, staining or sealing
- Great for covering damaged drywall, plaster or popcorn ceilings
- Easy retrofit option to cover old basement ceiling grid
- Update the look of your ceiling without losing ceiling height
- Items #1148 and 1149 are paintable
- Beveled tongue and groove edge minimizes the appearance of gaps during normal expansion and contraction
- Staggered installation means minimal waste
- Class C Fire Performance for residential spaces, based on E-84 testing
- Click here for information on how WoodHaven™ planks can be used on walls

PRODUCT SPECIFICATIONS

| Item # | Edge Detail | Dimensions (Inches) | Install System | Noise Reducing NRC/CAC | Sag Resistance | Mold Resistance | Light Reflectance | Fire Resistance | SF Per Ctn | Pcs/Ctn | Material Type |
|-------------------|---|---------------------|------------------------------|---|--|--|-------------------|---|------------|---------|---------------|
| 1148 & 1149 |  Beveled Tongue & Groove | 5 x 84 x 3/8 | Surface Mount (Direct Apply) |  -/- |  Standard |  Standard | 0.85 |  Class C | 29 | 10 | MDF |
| All Other Item #s |  Beveled Tongue & Groove | 5 x 84 x 3/8 | Surface Mount (Direct Apply) |  -/- |  Standard |  Standard | - |  Class C | 29 | 10 | MDF |



1140 WOODHAVEN™ CLASSIC WHITE (WALL)

WoodHaven™
CEILING & WALL PLANKS



INSTALL WOODHAVEN™ CEILINGS IN THREE DIFFERENT WAYS



Before starting your project, review complete installation instructions at ceilings.com/installwoodhaven for important design and installation considerations.

1 CLIPS AND SCREWS

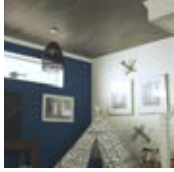

▲ Click link to watch video

Installation clips and screws are included in the plank package and install directly to furring strips (sold separately). This installation method is suitable for ceilings with a greater than 10 degree slope. Please contact Techline at 1-877-ARMSTRONG (276-7876) for guidance on how to install planks on a sloped ceiling.



▲ Click link to watch video

2 EASY UP® TRACKS AND CLIPS



▲ Click link to watch video

The Easy Up® installation system is fast and easy with snap-on (vs. screw-in) clips, and is the recommended method to install planks over drywall, plaster or popcorn ceilings. Use the Easy Up® installation system for ceilings with a less than 10 degree slope.

Item #1190 (20 tracks per carton)

Item #1191 (360 clips per carton—8 bags of 45 each) or Item #1191SC (135 clips per carton)

NOTE: Both track products and clip accessories are required for a complete Easy Up system and must be used together. Items are sold separately.

3 RETROFIT 15/16-in GRID

Transform an existing 15/16-in suspended (drop) ceiling using Easy Up® clips and WoodHaven™ planks.



▲ Click link to watch video

NOTE: Existing grid must be 15/16-in. Easy Up clips (sold separately) must be used for the retrofit installation. Screws and clips included in the WoodHaven package are only used where grid intersections interfere with the installation of an Easy Up clip.

Click here for estimating information and visit ceilings.com/installwoodhaven for full installation instructions, tips and design/space considerations.



1138 WOODHAVEN™ WOVEN WHITE (CEILING)

WoodHaven™
CEILING & WALL PLANKS

WOODHAVEN™ PLANKS ON WALLS

Consider the expanded range of decorating options with WoodHaven™ planks used on walls. Five design finishes — 1140 Classic White, 1148 Painted White, 1149 Beadboard, 1138 Woven White and 1139 Woven Charcoal Gray — are recommended for high-traffic areas. For other finishes, care must be taken to avoid scratching of surface in high-traffic areas.

HIGH-TRAFFIC WALL FINISHES



1140 CLASSIC WHITE

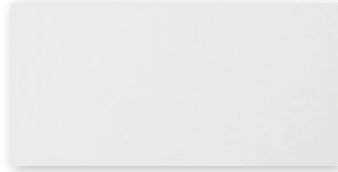

1148 PAINTED WHITE



1149 BEADBOARD



1138 WOVEN WHITE



1139 WOVEN CHARCOAL GRAY

FEATURES & BENEFITS

- Easy installation on walls: vertically with construction adhesive or horizontally with included clips
- All finishes can be used on walls; however, items #1140, 1148, 1149, 1138 and 1139 are recommended for high-traffic areas
- High-traffic finishes have a durable surface that is easily touched up if damaged
- Items #1148 and 1149 are paintable to match your interior

WALL INSTALLATION OPTIONS

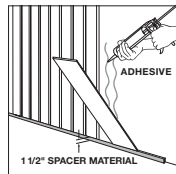
 With either option, finish with a trim of your choice.

Install vertically on a wall using construction adhesive. Follow the adhesive manufacturer's recommendations for surface preparation and application rate. Use painter's tape if necessary to hold planks in place until the adhesive sets up.

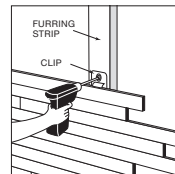

Install horizontally on a wall using clips included in the WoodHaven plank carton.



▲ [Click link to watch video](#)

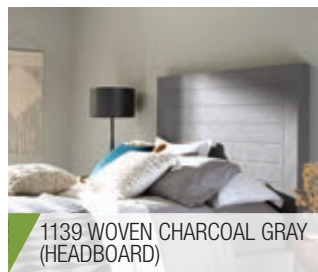

1139 WOVEN CHARCOAL GRAY (HEADBOARD)

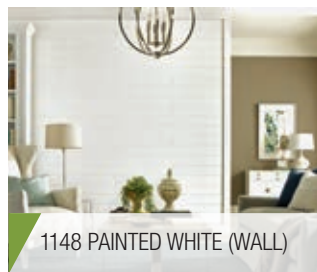

1148 PAINTED WHITE (WALL)

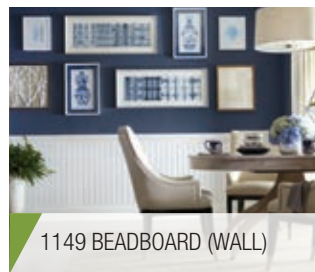

1149 BEADBOARD (WALL)



1138 WOVEN WHITE (WALL)

[Click here for estimating information](#)

For installation instructions, please visit ceilings.com/installwoodwalls



WOOD LOOK



SURFACE MOUNT (DIRECT APPLY) CEILINGS

480 COUNTRY CLASSIC™ PLANK (CEILING) AND 1149 WOODHAVEN™ BEADBOARD (WALL)

WoodLook

COUNTRY CLASSIC™ PLANK

The visual of our 6-in x 48-in Country Classic™ Plank provides a beautiful country rustic look as a cost-effective alternative to real wood planks. These easy-to-install mineral fiber ceiling planks are lightweight and easily cut with a utility knife.







480 COUNTRY CLASSIC™ PLANK

FEATURES & BENEFITS

- Made of mineral fiber (similar material to standard ceiling products)
- Real wood-grain appearance at an affordable price
- Paintable or stainable to match any décor
- Great for covering damaged drywall, plaster or popcorn ceilings

PRODUCT SPECIFICATIONS

| Item # | Edge Detail | Dimensions (Inches) | Install System | Noise Reducing NRC/CAC | Sag Resistance | Mold Resistance | Light Reflectance | Fire Resistance | SF Per Ctn | Pcs/Ctn | Material Type |
|--------|---|---------------------|----------------|--|--|--|-------------------|---|------------|---------|---------------|
| 480 |  Beveled Tongue & Groove | 6 x 48 x 1/2 | Easy Up® |  -/30 |  Standard |  Standard | 0.80 |  Class A | 40 | 20 | Mineral Fiber |

INSTALLATION SYSTEM

- Tongue & groove products have no visible grid
- Easy Up® installation system or adhesive

Click here for additional information

For installation instructions, please visit ceilings.com/installcountryclassic



▲ Click link to watch video



480 COUNTRY CLASSIC™ PLANK (CEILING)

WoodLook



HOW TO STAIN YOUR COUNTRY CLASSIC™ PLANK CEILING

ADD WARMTH TO A FAMILY ROOM OR CHARM TO A KITCHEN

There's nothing like the rustic look of wood. Our Country Classic™ planks give you the look of wood without the expense. Using a water-based gel stain on the planks, choose a light, medium, or dark color that complements the look and feel of your room.

Here's how:

Step 1 Select and test the stain color—light to dark to ensure the color of stain you choose complements your room. You may also use a water based paint and mix with an acrylic glaze finish to achieve the same wood look. Mix together 1 part paint and 6 parts glaze for a light-to-medium tone, or 1 part paint to 4 parts glaze for a darker tone.

Step 2 Stain planks—follow the manufacturer's instructions for applying the stain. For a darker stain, apply two coats, waiting 24 hours between coats and until dry.

Step 3 Install the planks; follow the installation instructions found in the carton.

NOTE: Armstrong Ceilings cannot guarantee that the published surface burning characteristics, fire resistance ratings, acoustical performance, dimensional stability/sag, or light reflectance will remain the same after repainting. Field painting or staining will void the warranty.



BEFORE: 480 COUNTRY CLASSIC™ PLANK

AFTER: 480 COUNTRY CLASSIC™ PLANK (FIELD STAINED)



5424234NLS METALLAIRE™ MEDALLION — NAIL-UP, LACQUERED STEEL (CEILING)
5400234BNA METALLAIRE™ MEDALLION — STAINLESS STEEL (BACKSPLASH)

Metallaire™

DECORATIVE CEILINGS
WALLS & BACKSPLASHES



METALLAIRE™ CEILINGS

Armstrong® Metallaire™ ceiling panels are made from real metal, coated to protect from rust, and have sag, mold, and mildew resistance. Panels are available as 24-in x 24-in suspended or 24-in x 48-in nail-up (surface mount) options.

CEILING STYLES



SMALL PANELS
24-in x 24-in SUSPENDED
5422204L
24-in x 48-in NAIL-UP
(SURFACE MOUNT)
5424204N

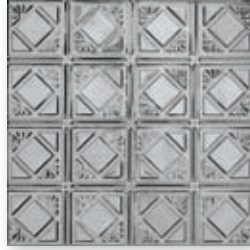

FANS
24-in x 24-in SUSPENDED
5422207L
24-in x 48-in NAIL-UP
(SURFACE MOUNT)
5424207N



SMALL FLORAL CIRCLE
24-in x 24-in SUSPENDED
5422209L
24-in x 48-in NAIL-UP
(SURFACE MOUNT)
5424209N



MEDIUM PANELS
24-in x 24-in SUSPENDED
5422320L
24-in x 48-in NAIL-UP
(SURFACE MOUNT)
5424320N



HAMMERED BORDER
24-in x 24-in SUSPENDED
5422509L
24-in x 48-in NAIL-UP
(SURFACE MOUNT)
5424509N



BEAD
24-in x 24-in SUSPENDED
5422504L
24-in x 48-in NAIL-UP
(SURFACE MOUNT)
5424504N

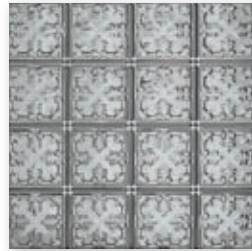

VINE
24-in x 24-in SUSPENDED
5422210L
24-in x 48-in NAIL-UP
(SURFACE MOUNT)
5424210N

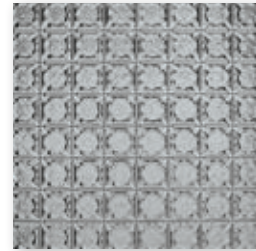

MEDALLION
24-in x 24-in SUSPENDED
5422234L
24-in x 48-in NAIL-UP
(SURFACE MOUNT)
5424234N



LARGE FLORAL CIRCLE
24-in x 24-in SUSPENDED
5422309L
24-in x 48-in NAIL-UP
(SURFACE MOUNT)
5424309N



HAMMERED TREFOIL
24-in x 24-in SUSPENDED
5422321L
24-in x 48-in NAIL-UP
(SURFACE MOUNT)
5424321N

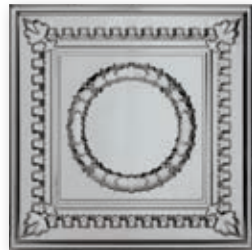

WREATH
24-in x 24-in SUSPENDED
5422503L
24-in x 48-in NAIL-UP
(SURFACE MOUNT)
5424503N



LARGE PANEL
24-in x 24-in SUSPENDED
5422505L
24-in x 48-in NAIL-UP
(SURFACE MOUNT)
5424505N

FINISHES



WH – WHITE

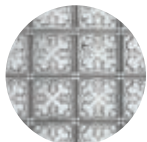

AM – CHROME



LS – LACQUERED STEEL

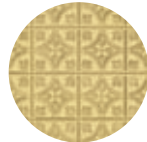

AR – BRASS



CP – COPPER

Metallaire™

DECORATIVE CEILINGS
WALLS & BACKSPASHES

FEATURES & BENEFITS

- Beautiful 19th Century historical patterns
- Real metal, coated to protect from rust
- Available in 5 finishes, 12 patterns, and 2 sizes: 24-in x 24-in suspended panels or 24-in x 48-in nail-up (surface mount) panels
- Sag, mold and mildew resistance
- Ideal for accent wall applications—use stainless steel backsplash panels for kitchen or bathroom applications
- Coordinating accessories are available—grid kits, cornices, cone head nails and filler panels

PRODUCT SPECIFICATIONS

| Item # | Edge Detail | Dimensions (Inches) | Install System | Noise Reducing NRC/CAC | Sag Resistance | Mold Resistance | Light Reflectance | Fire Resistance | SF Per Ctn | Pcs/Ctn | Material Type |
|---------|-----------------|---------------------|----------------|------------------------|----------------|-----------------|-------------------|-----------------|------------|---------|---------------|
| Various | Visible grid | 24 x 24 | 15/16-in | -/- | Superior | Superior | – | Class A | Various | Various | Metal |
| Various | No visible grid | 24 x 48 | Nail-up | -/- | Superior | Superior | – | Class A | Various | Various | Metal |

CEILING INSTALLATION OPTIONS



▲ Click link to watch video

24-in x 24-in Suspended (Drop)

Coordinating 15/16-in grid kits* for Metallaire™ ceilings are available for suspended installation.

*Sold separately



▲ Click link to watch video

24-in x 48-in Nail-up (Surface Mount)

Apply directly to your ceiling using cone head nails* in a coordinating finish.

For detailed installation instructions, please visit ceilings.com/installmetallaire

NOTE: Metallaire™ panels are produced from steel or aluminum yet they are designed to emulate an antique-type visual. Periodic “wrinkles” or dents may cause the panel to appear not to be flat; these characteristics add to the antique effect and are not considered manufacturing defects.

For help with planning your Metallaire ceiling, please visit ceilings.com/metallaireplanning



5424207NCP METALLAIRE™ FANS—NAIL UP (SURFACE MOUNT), COPPER (CEILING)

For tips on how to install a Metallaire ceiling accent cloud, please visit ceilings.com/accentcloud



ACCESSORIES (Sold separately)

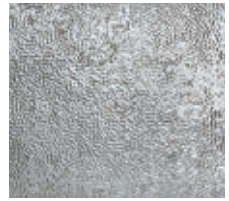

FILLER PANELS

5422235L—24-in x 24-in Suspended (Drop)—add color suffix letters
 5424235N—24-in x 48-in Nail-up (Surface Mount)—add color suffix letters
 Filler panels are used around the edge of the room when less than full panels are needed. Filler panels are available in matching finishes. Available in Chrome (AM); Lacquered Steel (LS); Brass (AR); Copper (CP); White (WH).



FILLER PANEL AND CORNICE APPLICATION

SUSPENDED ACCESSORIES



COORDINATING GRID KITS

5400G—add NEW color suffix found below
 Grid kits are available for 24-in x 24-in lay-in suspended installation; now with QuickHang™ hooks and brackets (Click here for additional information). Colors available to coordinate with all finishes for Metallaire™ ceilings: available in Chrome/Lacquered Steel (AM1); Brass (AR1); Copper (CP1); White (WH1). Grid kits install 64 square feet of ceiling panels per carton.



HOLD DOWN CLIPS

5400HDC
 Hold Down Clips will hold panels flat and stop movement when air flow or vibration is a factor. Each carton contains enough clips to hold down 200 square feet of Metallaire suspended ceiling panels.
 NOTE: Panel removal may be more difficult when using clips.

SURFACE MOUNT ACCESSORIES



CONE HEAD NAILS

5400N—add color suffix letters found below
 Cone head nails are available in coordinating finishes to install a 24-in x 48-in nail up (surface mount) ceiling. Available in Chrome/Lacquered Steel (AM); Brass (AR); Copper (CP); White (WH). Each carton of nails installs 200 square feet of ceiling panels.

CORNICES

A cornice is the finishing detail that can complement and accentuate the exquisite detail of your Metallaire™ ceiling. Cornices are available in all 5 finishes, 6 patterns and are 48-in length. Add the color suffix Chrome (AM); Lacquered Steel (LS); Brass (AR); Copper (CP); White (WH) to the item number below.

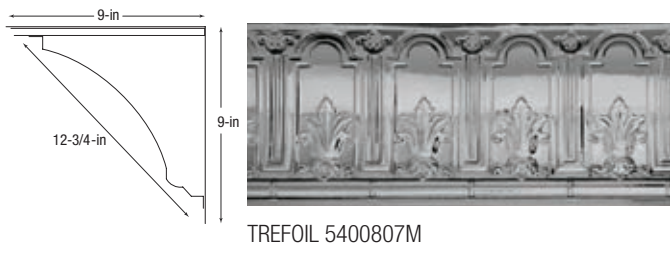
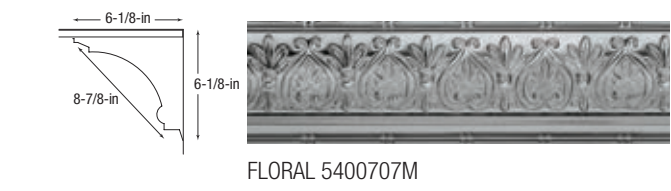
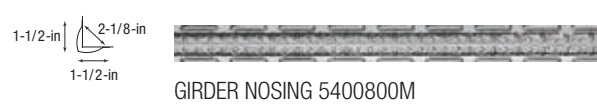

METALLAIRE™ BACKSPLASH AND ACCENT WALL APPLICATIONS

Stainless steel Metallaire™ panels are the best option to add or update a backsplash. The material is naturally resistant to rust, and the 18 1/2-in x 48 1/2-in panel size is appropriate for typical applications.

Metallaire surface mount panels can also be used as accent wall panels or possibly as a backsplash in certain applications. The larger, 24-in x 48-in panels are made of real metal and, while coated to protect from rust, it's important to avoid nicks, abrasive cleaners, and prolonged exposure to steam or water to maintain the product's appearance and performance.

BACKSPLASH STYLES



SMALL PANELS
5400204BNA



FANS
5400207BNA



SMALL FLORAL CIRCLE
5400209BNA

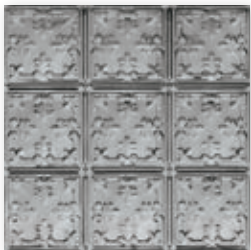

VINE
5400210BNA

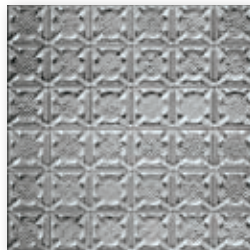

MEDALLION
5400234BNA



5400209BNA METALLAIRE™ SMALL FLORAL CIRCLE—
STAINLESS STEEL (BACKSPLASH)





Metallaire™
DECORATIVE CEILINGS
WALLS & BACKSPLASHES



FEATURES & BENEFITS

- Beautiful 19th Century historical patterns
- Made of stainless steel, the best backsplash option
- Mold and mildew resistance
- Pre-cut at 18 1/2-in x 48 1/2-in to fit most standard kitchens
- Also ideal for other accent walls

BACKSPLASH PRODUCT SPECIFICATIONS

| Item # | Edge Detail | Dimensions (Inches) | Install System | Noise Reducing NRC/CAC  | Sag Resistance  | Mold Resistance  | Light Reflectance | Fire Resistance  | SF Per Ctn | Pcs/Ctn | Material Type |
|--------|-------------|---------------------|----------------|--|--|---|-------------------|---|------------|-------------------|-----------------|
| All | N/A | 18 1/2 x 48 1/2 | Direct Apply | -/- | Superior | Superior | - | Class A | Various | Sold by the piece | Stainless Steel |

BACKSPLASH OR WALL INSTALLATION

Use adhesive to attach the panels to the wall. Use just enough cone head nails to secure the panels to the wall while the adhesive sets up. (Do not remove nails.)

For installation instructions, please visit ceilings.com/installmetalwalls



▲ Click link to watch video



5424207NCP METALLAIRE™ FANS (WALL)

Metallaire™

DECORATIVE CEILINGS
WALLS & BACKSPASHES



1280BXA EASY ELEGANCE™ DEEP COFFER WHITE WITH 1278 FLAT WHITE BORDER (CEILING)

EasyElegance™
PVC PLASTIC CEILING PANELS



EASY ELEGANCE™ COFFERED CEILING PANELS

Armstrong® Easy Elegance™ Coffered ceiling panels are made of rigid PVC plastic and are available in both deep and shallow options. Panels offer moisture, mold and mildew resistance and are maintenance-free.

STYLES



1280BXA EASY ELEGANCE™
DEEP COFFER WHITE



1280BLBXA EASY ELEGANCE
DEEP COFFER BLACK



1282BXA EASY ELEGANCE
SHALLOW COFFER WHITE



1282BLBXA EASY ELEGANCE
SHALLOW COFFER BLACK

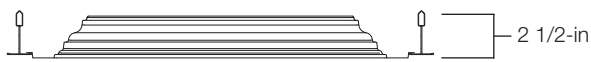

SIDE VIEW



SIDE VIEW



1280BLBXA EASY ELEGANCE™ DEEP COFFER BLACK (CEILING)

FEATURES & BENEFITS

- Made of lightweight PVC (plastic)
- Sophisticated coffer look at a fraction of the cost of custom work
- Sag resistance
- Drywall perimeter border recommended for a high-end finished look
- Easy Elegance™ Flat panels and Textured panels can also be used as a perimeter border; see next pages for details
- For residential use only – ASTM E84 (Class A)
- Easy installation system provides access to pipes, ducts and wiring

For additional details about perimeter borders, visit ceilings.com/coffersfaq



▲ Click link to watch video

EasyElegance™
PVC PLASTIC CEILING PANELS

EASY ELEGANCE™ FLAT AND TEXTURED CEILING PANELS

Easy Elegance™ Flat and Textured square edge ceiling panels are made of rigid PVC plastic and are available in two sizes—24-in x 24-in and 24-in x 48-in. Panels can be used alone or as a perimeter border for Easy Elegance™ Coffered ceiling panels.*

FEATURES & BENEFITS

- Rigid PVC Plastic
- Flat White panels have a bright white, satin finish
- Flat Black panels have a black, matte finish
- Textured White and Textured Black panels have a low-gloss cobbled finish
- Easy to clean—washable
- Durable—impact resistant
- Mold, mildew, and sag resistance
- Stain resistant
- Will not discolor
- Lightweight—easy to cut and install in 15/16-in standard grid
- Paintable
- For residential use only – ASTM E84 (Class A)

* NOTE: Color of Flat White panels and Textured White panels may not be an exact match with White Coffer panel color.

FLAT PANEL STYLES



1278 EASY ELEGANCE™
FLAT WHITE

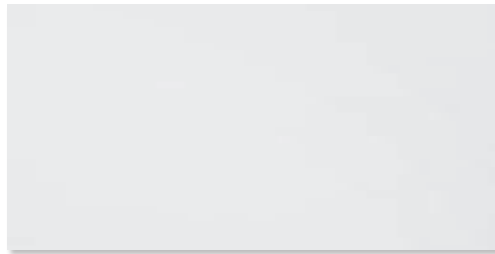

1279 EASY ELEGANCE FLAT WHITE

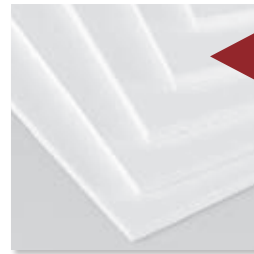

SHOWING
SQUARE
EDGE
DETAIL



1278BL EASY ELEGANCE
FLAT BLACK



1279BL EASY ELEGANCE FLAT BLACK

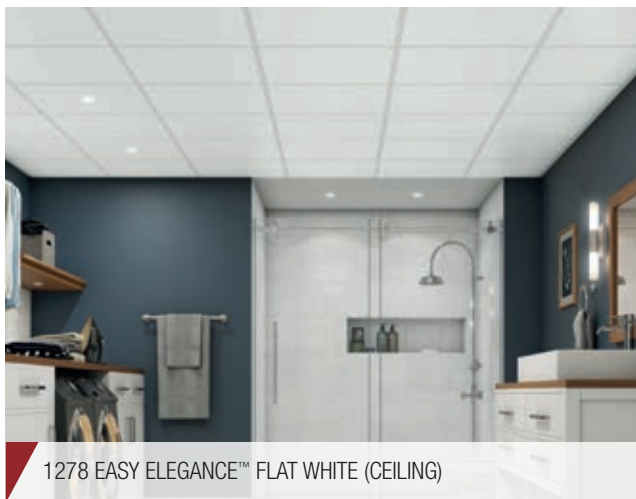

1278 EASY ELEGANCE™ FLAT WHITE (CEILING)



1280BXA EASY ELEGANCE™ DEEP COFFER WHITE WITH
1278 FLAT WHITE USED AS A PERIMETER BORDER

FLAT
WHITE
BORDER
PANEL

TEXTURED PANEL STYLES



1283 EASY ELEGANCE™
TEXTURED WHITE

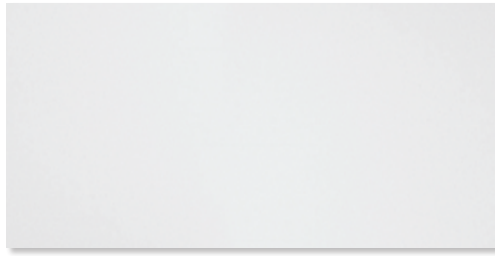

1284 EASY ELEGANCE TEXTURED WHITE

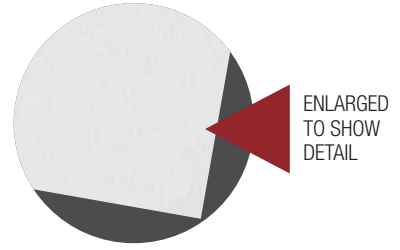

1283BL EASY ELEGANCE
TEXTURED BLACK

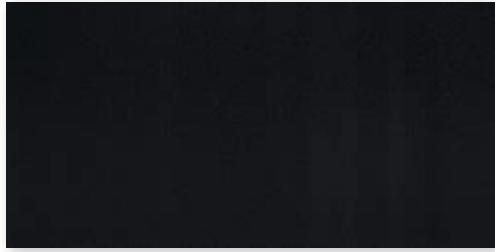

1284BL EASY ELEGANCE TEXTURED BLACK



1284 EASY ELEGANCE™ TEXTURED WHITE (CEILING)

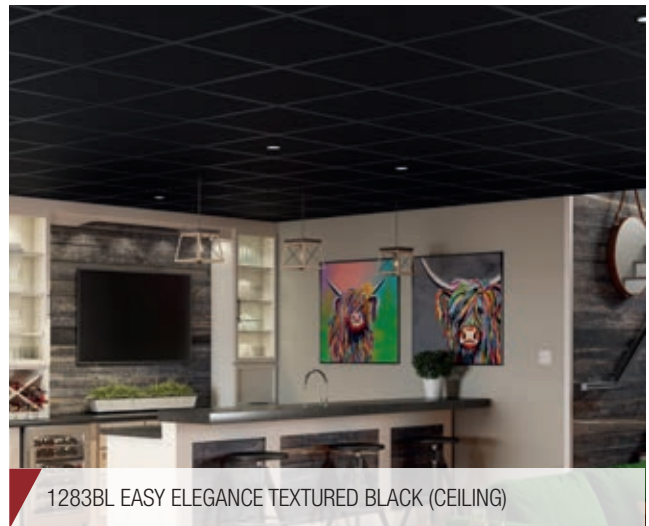

1283BL EASY ELEGANCE TEXTURED BLACK (CEILING)

PVC PLASTIC



SUSPENDED (DROP) CEILINGS

EasyElegance™
PVC PLASTIC CEILING PANELS

PRODUCT SPECIFICATIONS

| Item # | Edge Detail | Dimensions (Inches) | Install System | Noise Reducing NRC/CAC | Sag Resistance | Mold Resistance | Fog | Spray | Wipe | Light Reflectance | Fire Resistance | SF Per Ctn | Pcs/ Ctn | Material Type |
|------------------------------|-------------|---------------------|----------------|------------------------|----------------|-----------------|-----|-------|------|-------------------|-----------------|------------|----------|---------------|
| Coffer Ceiling Panels | | | | | | | | | | | | | | |
| 1280BXA | Tegular | 24 x 24 x 2 1/2 | 15/16-in | -/- | Superior | Superior | - | - | - | 0.85 | Class A | 4 | 1** | Rigid PVC |
| 1280BLBXA* | Tegular | 24 x 24 x 2 1/2 | 15/16-in | -/- | Superior | Superior | - | - | - | - | Class A | 4 | 1** | Rigid PVC |
| 1282BXA | Tegular | 24 x 24 x 7/10 | 15/16-in | -/- | Superior | Superior | - | - | - | 0.85 | Class A | 4 | 1** | Rigid PVC |
| 1282BLBXA* | Tegular | 24 x 24 x 7/10 | 15/16-in | -/- | Superior | Superior | - | - | - | - | Class A | 4 | 1** | Rigid PVC |
| Flat Panels | | | | | | | | | | | | | | |
| 1278 | Square | 24 x 24 x 1/5 | 15/16-in | -/- | Superior | Superior | - | ✓ | ✓ | 0.90 | Class A | 40 | 10 | Rigid PVC |
| 1278BL | Square | 24 x 24 x 1/5 | 15/16-in | -/- | Superior | Superior | - | ✓ | ✓ | - | Class A | 40 | 10 | Rigid PVC |
| 1279 | Square | 24 x 48 x 1/5 | 15/16-in | -/- | Superior | Superior | - | ✓ | ✓ | 0.90 | Class A | 64 | 8 | Rigid PVC |
| 1279BL | Square | 24 x 48 x 1/5 | 15/16-in | -/- | Superior | Superior | - | ✓ | ✓ | - | Class A | 64 | 8 | Rigid PVC |
| Textured Panels | | | | | | | | | | | | | | |
| 1283 | Square | 24 x 24 x 1/5 | 15/16-in | -/- | Superior | Superior | - | ✓ | ✓ | - | Class A | 40 | 10 | Rigid PVC |
| 1283BL | Square | 24 x 24 x 1/5 | 15/16-in | -/- | Superior | Superior | - | ✓ | ✓ | - | Class A | 40 | 10 | Rigid PVC |
| 1284 | Square | 24 x 48 x 1/5 | 15/16-in | -/- | Superior | Superior | - | ✓ | ✓ | - | Class A | 64 | 8 | Rigid PVC |
| 1284BL | Square | 24 x 48 x 1/5 | 15/16-in | -/- | Superior | Superior | - | ✓ | ✓ | - | Class A | 64 | 8 | Rigid PVC |

*Coordinating 64 sq. ft. black grid kits (6362BL) are available
 **Coffer items are sold by the piece; minimum order quantity of 4

INSTALLATION SYSTEM

- Tegular edge products minimize grid look
- Square edge products have a visible grid
- Prelude® 15/16-in suspension system

Click here for additional information

For installation instructions, please visit ceilings.com/installation

NOTE: Discover how to enhance your suspended ceiling installation with StyleStix™ PVC suspended ceiling grid moldings; visit ceilings.com/stylestix



1310BX, 1311BX, 1312BX STYLESTIX™ WITH 273 SAHARA™ PANELS (CEILING)



1205 SINGLE RAISED PANEL (CEILING)

DECORATIVE LOOK



SUSPENDED (DROP) CEILINGS

DecorativeLook

24-in x 24-in DECORATIVE CEILINGS



1201 RAISED PANEL™



1202 SCALLOPED

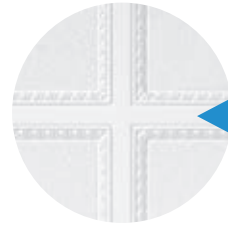

ENLARGED
TO SHOW
DETAIL



1203 FLUTED



1205 SINGLE RAISED PANEL
1210 SINGLE RAISED PANEL



1206 TANGO



1270 CASCADE®



8008 TINCRAFT™ CIRCLES



8009 TINCRAFT™ SQUARES















DecorativeLook



FEATURES & BENEFITS

- Variety of decorative styles to enhance any décor
- Grid-blending design masks the industrial look of metal grid
- For a narrow grid look, 8009 and 1210 install on 9/16-in Suprafine® grid
- Easy installation system provides access to pipes, ducts and wiring

PRODUCT SPECIFICATIONS

| Item # | Edge Detail | Dimensions (Inches) | Install System | Noise Reducing NRC/CAC  | Sag Resistance  | Mold Resistance  | Light Reflectance | Fire Resistance  | SF Per Ctn | Pcs/Ctn | Material Type |
|--------|---|---------------------|----------------|--|--|---|-------------------|---|------------|---------|---------------|
| 1201 |  Tegular | 24 x 24 x 5/8 | 15/16-in | -/30 | Standard | Standard | 0.78 | Class A | 24 | 6 | Mineral Fiber |
| 1202 |  Tegular | 24 x 24 x 5/8 | 15/16-in | -/30 | Standard | Standard | 0.78 | Class A | 24 | 6 | Mineral Fiber |
| 1203 |  Tegular | 24 x 24 x 5/8 | 15/16-in | -/30 | Standard | Standard | 0.78 | Class A | 24 | 6 | Mineral Fiber |
| 1205 |  Tegular | 24 x 24 x 5/8 | 15/16-in | -/30 | Standard | Standard | 0.78 | Class A | 24 | 6 | Mineral Fiber |
| 1206 |  Tegular | 24 x 24 x 5/8 | 15/16-in | -/30 | Standard | Standard | 0.78 | Class A | 24 | 6 | Mineral Fiber |
| 1210 |  Tegular | 24 x 24 x 3/4 | 9/16-in | -/30 | Standard | Standard | 0.78 | Class A | 24 | 6 | Mineral Fiber |
| 1270 |  Tegular | 24 x 24 x 3/4 | 15/16-in | -/30 | Standard | Standard | 0.80 | Class A | 48 | 12 | Mineral Fiber |
| 8008 |  Tegular | 24 x 24 x 3/4 | 15/16-in | -/35 | Standard | Standard | 0.78 | Class A | 48 | 12 | Mineral Fiber |
| 8009 |  Tegular | 24 x 24 x 3/4 | 9/16-in | -/35 | Standard | Standard | 0.78 | Class A | 32 | 8 | Mineral Fiber |



1270 CASCADE® (CEILING)

INSTALLATION SYSTEM

- Tegular edge products minimize grid look
- Prelude® 15/16-in suspension system
- Suprafine® 9/16-in suspension system (1210 and 8009 only)

Click here for additional information

For installation instructions, please visit ceilings.com/installation



271 SAHARA™ (CEILING)—Similar look can be achieved with 24-in x 48-in 9768 SAHARA™ SCORED II

SmoothLook

24-in x 24-in SMOOTH LOOK CEILINGS



269 SAND PEBBLE™

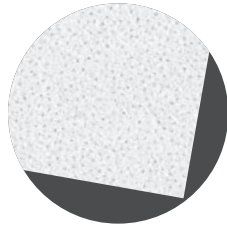

271 SAHARA™
273 SAHARA
276 SAHARA

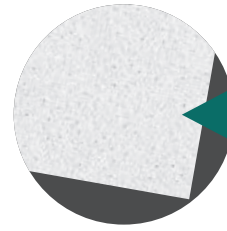

ENLARGED
TO SHOW
DETAIL



490 YUMA WHITE®
492 YUMA WHITE

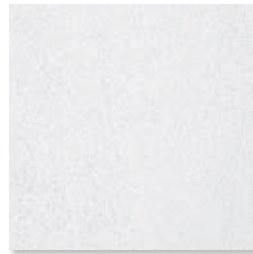
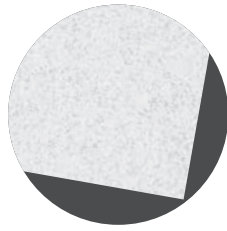

973 LUMAWASH®

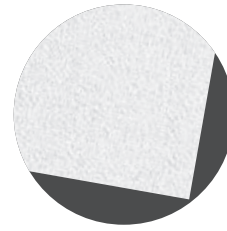

1231 BRIGHTEX™ WITH
AIRGUARD™

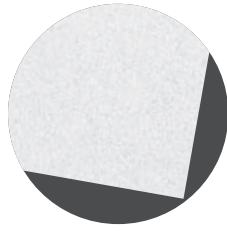

SMOOTH LOOK



SUSPENDED (DROP) CEILINGS

SmoothLook

FEATURES & BENEFITS

- Ideal for basements, home theaters and light commercial spaces
- Mold, mildew, and sag resistance
- Acoustical; most absorb >50% of noise (except 973)
- Easy installation system provides access to pipes, ducts and wiring
- For a narrow grid look, 276 and 1231 install on 9/16-in Suprafine® grid
- 973 meets USDA guidelines for use in food processing areas



269 SAND PEBBLE™ (CEILING)

SmoothLook

24-in x 48-in SMOOTH LOOK CEILINGS



280 PLAIN WHITE

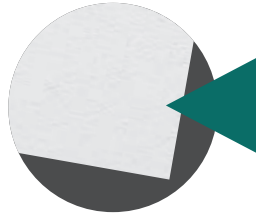

ENLARGED
TO SHOW
DETAIL



491 YUMA WHITE®
493 YUMA WHITE

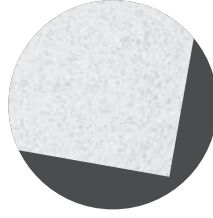

972 LUMAWASH®

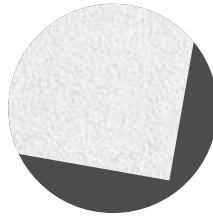

9768 SAHARA™ SCORED II

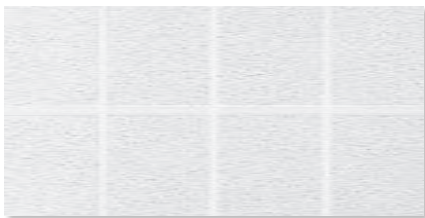
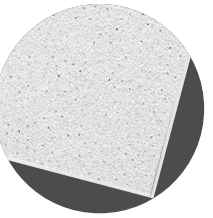

9769 SAHARA™ SCORED I

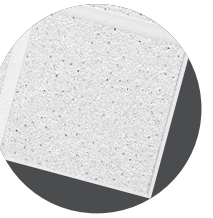



















FEATURES & BENEFITS

- Great for new, replacement and matching ceilings
- Mold, mildew, and sag resistance
- Acoustical; most absorb >50% of noise (except 280 and 972)
- Easy installation system provides access to pipes, ducts and wiring
- 972 meets USDA guidelines for use in food processing areas
- 9768 and 9769 are scored to give a 2-ft x 2-ft or a 1-ft x 1-ft visual on a 2-ft x 4-ft panel



SmoothLook

PRODUCT SPECIFICATIONS

| Item # | Edge Detail | Dimensions (Inches) | Install System | Noise Reducing NRC/CAC  | Sag Resistance  | Mold Resistance  | Fog  | Spray  | Wipe  | Light Reflectance | Fire Resistance  | SF Per Ctn | Pcs/Ctn | Material Type |
|--------|---|---------------------|----------------|--|--|---|---|---|--|-------------------|---|------------|---------|---------------|
| 269 |  Tegular | 24 x 24 x 5/8 | 15/16-in | 0.55/30 | Superior | Superior | - | - | - | 0.80 | Class A | 64 | 16 | Mineral Fiber |
| 271 |  Tegular | 24 x 24 x 5/8 | 15/16-in | 0.50/35 | Superior | Superior | - | - | - | 0.81 | Class A | 64 | 16 | Mineral Fiber |
| 273 |  Square | 24 x 24 x 5/8 | 15/16-in | 0.50/35 | Superior | Superior | - | - | - | 0.81 | Class A | 64 | 16 | Mineral Fiber |
| 276 |  Tegular | 24 x 24 x 5/8 | 9/16-in | 0.50/35 | Superior | Superior | - | - | - | 0.81 | Class A | 64 | 16 | Mineral Fiber |
| 280 |  Square | 24 x 48 x 1/2 | 15/16-in | -/30 | Standard | Standard | - | - | - | 0.80 | Class A | 64 | 8 | Mineral Fiber |
| 490 |  Square | 24 x 24 x 5/8 | 15/16-in | 0.55/35 | Superior | Superior | - | - | - | 0.80 | Class A | 64 | 16 | Mineral Fiber |
| 491 |  Square | 24 x 48 x 5/8 | 15/16-in | 0.55/35 | Superior | Superior | - | - | - | 0.80 | Class A | 64 | 8 | Mineral Fiber |
| 492 |  Tegular | 24 x 24 x 5/8 | 15/16-in | 0.55/35 | Superior | Superior | - | - | - | 0.80 | Class A | 64 | 16 | Mineral Fiber |
| 493 |  Tegular | 24 x 48 x 5/8 | 15/16-in | 0.55/35 | Superior | Superior | - | - | - | 0.80 | Class A | 64 | 8 | Mineral Fiber |
| 972 |  Square | 24 x 48 x 5/8 | 15/16-in | -/33 | Superior | Superior | ✓ | ✓ | ✓ | 0.89 | Class A | 64 | 8 | Mineral Fiber |
| 973 |  Square | 24 x 24 x 5/8 | 15/16-in | -/33 | Superior | Superior | ✓ | ✓ | ✓ | 0.89 | Class A | 64 | 16 | Mineral Fiber |
| 1231 |  Tegular | 24 x 24 x 3/4 | 9/16-in | 0.65/35 | Superior | Superior | - | - | - | 0.88 | Class A | 32 | 8 | Mineral Fiber |
| 9768 |  Tegular | 24 x 48 x 3/4 | 15/16-in | 0.50/35 | Superior | Superior | - | - | - | 0.81 | Class A | 64 | 8 | Mineral Fiber |
| 9769 |  Tegular | 24 x 48 x 3/4 | 15/16-in | 0.50/35 | Superior | Superior | - | - | - | 0.81 | Class A | 64 | 8 | Mineral Fiber |

INSTALLATION SYSTEM

- Tegular edge products minimize grid look
- Square edge products have a visible grid
- Prelude® 15/16-in suspension system
- Suprafine® 9/16-in suspension system (276 and 1231 only)

Click here for additional information

For installation instructions, please visit ceilings.com/installation

SMOOTH LOOK



SUSPENDED (DROP) CEILING

SmoothLook



954 CLASSIC FINE TEXTURED (CEILING)

TexturedLook

24-in x 24-in TEXTURED LOOK CEILING



241 SUPERTUFF™

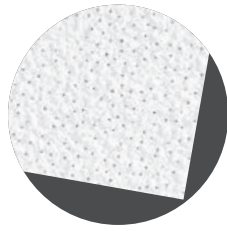

266 BRIGHTON™

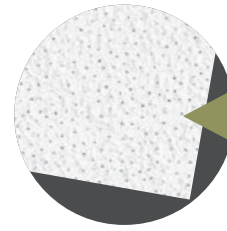

ENLARGED
TO SHOW
DETAIL



928 FINE FISSURED™
932 FINE FISSURED

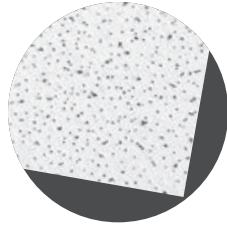

934 RANDOM TEXTURED
935 RANDOM TEXTURED

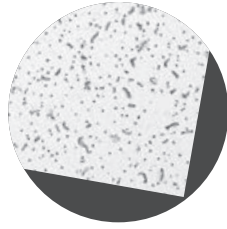

949 TEXTURED

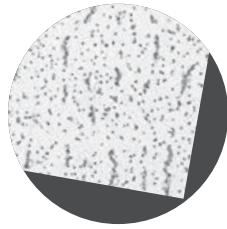

954 CLASSIC FINE TEXTURED

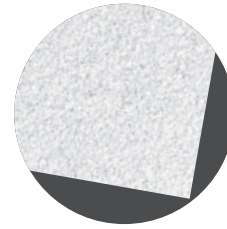

1728BL FINE FISSURED™
BLACK

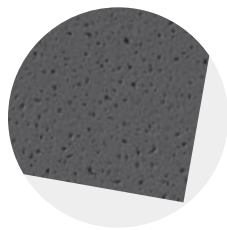

TEXTURED LOOK



SUSPENDED (DROP) CEILING

TexturedLook

FEATURES & BENEFITS

- Ideal for basements and home theaters
- Acoustical; most absorb >50% of noise (except 266)
- Easy installation system provides access to pipes, ducts and wiring
- 241, 928, 932, 954 and 1728BL offer economical high performance (sag, mold, and mildew resistance) and a range of visuals

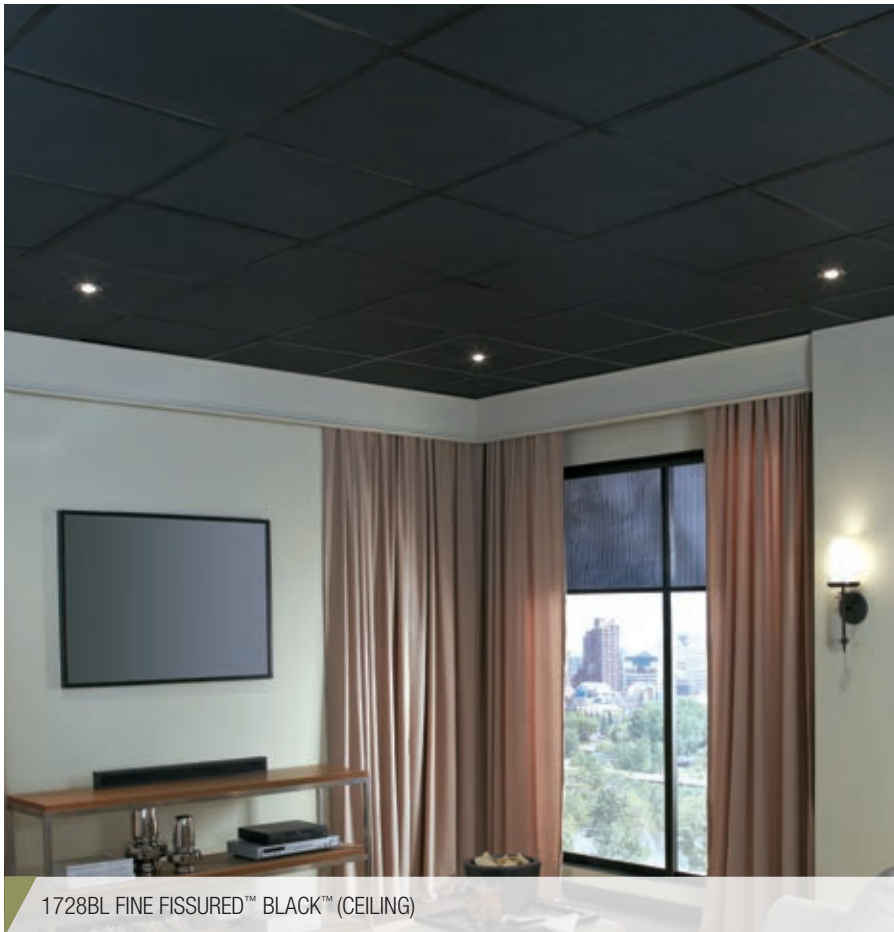

1728BL FINE FISSURED™ BLACK™ (CEILING)

NOTE: Coordinating 64 sq. ft. black grid kits (6362BL) are available

TexturedLook



24-in x 48-in TEXTURED LOOK CEILINGS



297 GRENOBLE™

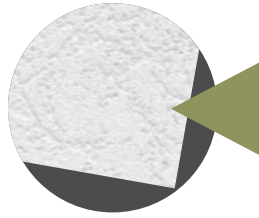

ENLARGED TO SHOW DETAIL



915 Textured FIRE GUARD™

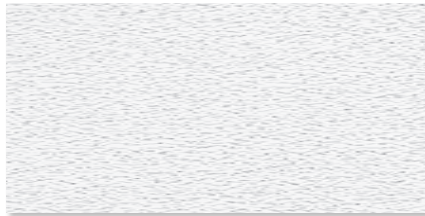
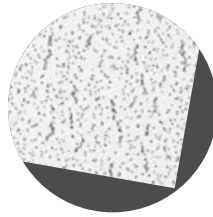

922 FINE FISSURED™

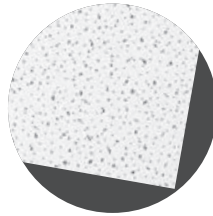

FEATURES & BENEFITS

- Great for new, replacement and matching ceilings
- Many are acoustical; reduce noise 55%
- Non-directional image reduces labor and scrap (922, 933 and 9767)
- Easy installation system provides access to pipes, ducts and wiring
- 915 must be installed in a Fire Guard™ grid to achieve fire resistant UL ratings
- 922 offers economical high performance (sag, mold and mildew resistance) and a more subtle textured visual



922 FINE FISSURED™ (CEILING)

TexturedLook

24-in x 48-in TEXTURED LOOK CEILINGS *(continued)*



933 RANDOM TEXTURED

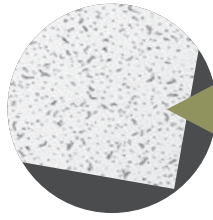

ENLARGED
TO SHOW
DETAIL



942 TEXTURED

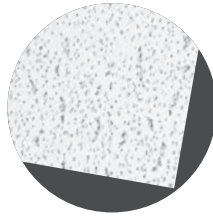

9767 SCORED

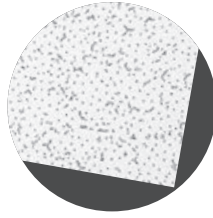

TexturedLook

TexturedLook
9767 SCORED (CEILING)



PRODUCT SPECIFICATIONS

| Item # | Edge Detail | Dimensions (Inches) | Install System | Noise Reducing NRC/CAC | Sag Resistance | Mold Resistance | Fog | Spray | Wipe | Light Reflectance | Fire Resistance | SF Per Ctn | Pcs/Ctn | Material Type |
|---------|-------------|---------------------|----------------|------------------------|----------------|-----------------|-----|-------|------|-------------------|-----------------|------------|---------|---------------|
| 241 | Tegular | 24 x 24 x 5/8 | 15/16-in | 0.50/33 | Superior | Superior | - | - | - | 0.86 | Class A | 48 | 12 | Mineral Fiber |
| 266 | Tegular | 24 x 24 x 1/2 | 15/16-in | 0.45/30 | Standard | Superior | - | - | - | 0.86 | Class A | 64 | 16 | Mineral Fiber |
| 297 | Square | 24 x 48 x 1/2 | 15/16-in | -/30 | Standard | Standard | - | - | - | 0.80 | Class A | 64 | 8 | Mineral Fiber |
| 915 | Square | 24 x 48 x 5/8 | 15/16-in | 0.55/35 | Standard | Standard | - | - | - | 0.79 | Class A | 64 | 8 | Mineral Fiber |
| 922 | Square | 24 x 48 x 5/8 | 15/16-in | 0.55/35 | Superior | Superior | ✓ | - | - | 0.82 | Class A | 64 | 8 | Mineral Fiber |
| 928 | Square | 24 x 24 x 5/8 | 15/16-in | 0.55/33 | Superior | Superior | ✓ | - | - | 0.82 | Class A | 64 | 16 | Mineral Fiber |
| 932 | Tegular | 24 x 24 x 5/8 | 15/16-in | 0.55/35 | Superior | Superior | ✓ | - | - | 0.82 | Class A | 64 | 16 | Mineral Fiber |
| 933 | Square | 24 x 48 x 5/8 | 15/16-in | 0.55/35 | Standard | Standard | - | - | - | 0.80 | Class A | 80 | 10 | Mineral Fiber |
| 934 | Tegular | 24 x 24 x 5/8 | 15/16-in | 0.55/33 | Standard | Standard | - | - | - | 0.80 | Class A | 64 | 16 | Mineral Fiber |
| 935 | Square | 24 x 24 x 5/8 | 15/16-in | 0.55/33 | Standard | Standard | - | - | - | 0.80 | Class A | 64 | 16 | Mineral Fiber |
| 942 | Square | 24 x 48 x 5/8 | 15/16-in | 0.55/30 | Standard | Standard | - | - | - | 0.79 | Class A | 80 | 10 | Mineral Fiber |
| 949 | Square | 24 x 24 x 5/8 | 15/16-in | 0.55/33 | Standard | Standard | - | - | - | 0.79 | Class A | 64 | 16 | Mineral Fiber |
| 954 | Tegular | 24 x 24 x 3/4 | 15/16-in | 0.70/35 | Superior | Superior | - | - | - | 0.85 | Class A | 48 | 12 | Mineral Fiber |
| 1728BL* | Square | 24 x 24 x 5/8 | 15/16-in | 0.55/33 | Superior | Superior | - | - | - | 0.06 | Class A | 64 | 16 | Mineral Fiber |
| 9767 | Tegular | 24 x 48 x 3/4 | 15/16-in | 0.55/35 | Standard | Standard | - | - | - | 0.82 | Class A | 80 | 10 | Mineral Fiber |

*Coordinating 64 sq. ft. black grid kits (6362BL) are available.

INSTALLATION SYSTEM

- Tegular edge products minimize grid look
- Square edge products have a visible grid
- Prelude® 15/16-in suspension system

Click here for additional information

For installation instructions, please visit ceilings.com/installation

TexturedLook

24-in x 48-in FIBERGLASS CEILINGS

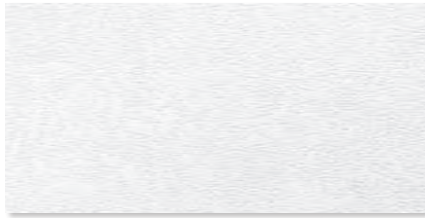

403 ESPRIT® FIBERGLASS

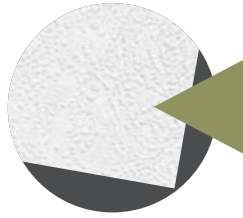

ENLARGED
TO SHOW
DETAIL

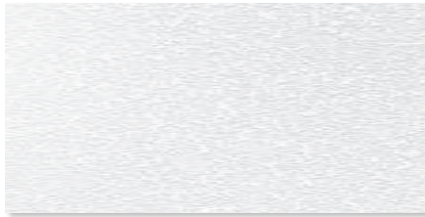

410 SONOFLEX™ RANDOM FISSURED™ FIBERGLASS

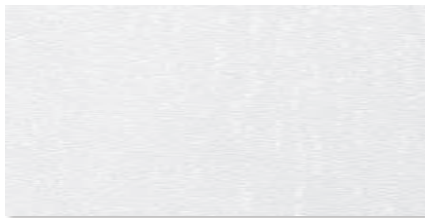
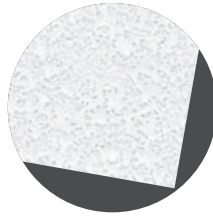

416 SONOFLEX™ ETCHED FIBERGLASS

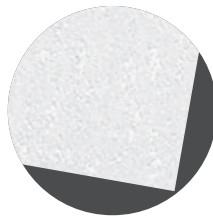







FEATURES & BENEFITS

- Great for new, replacement and matching commercial applications
- Easy installation system provides access to pipes, ducts and wiring
- Acoustical; reduce noise >50%
- Sag, mold, and mildew resistance
- Offers a lightweight, easy to handle alternative to traditional mineral fiber ceiling options

TexturedLook



PRODUCT SPECIFICATIONS

| Item # | Edge Detail | Dimensions (Inches) | Install System | Noise Reducing NRC/CAC  | Sag Resistance  | Mold Resistance  | Light Reflectance | Fire Resistance  | SF Per Ctn | Pcs/Ctn | Material Type |
|--------|--|---------------------|----------------|--|--|---|-------------------|---|------------|---------|---------------|
| 403 |  Square | 24 x 48 x 5/8 | 15/16-in | 0.55/- | Superior | Superior | 0.72 | Class A | 128 | 16 | Fiberglass |
| 410 |  Square | 24 x 48 x 5/8 | 15/16-in | 0.55/- | Superior | Superior | 0.72 | Class A | 128 | 16 | Fiberglass |
| 416 |  Square | 24 x 48 x 5/8 | 15/16-in | 0.55/- | Superior | Superior | 0.72 | Class A | 128 | 16 | Fiberglass |

INSTALLATION SYSTEM

- Square edge products have a visible grid
- Prelude® 15/16-in suspension system

Click here for additional information

For installation instructions, please visit ceilings.com/installation



403 ESPRIT® FIBERGLASS (CEILING)

TexturedLook



46 WELLINGTON™ (CEILING)

TinLook™
PAINTABLE CEILINGS



12-in x 12-in TINLOOK™ CEILINGS



46 WELLINGTON™



1240 TINTILE™



ENLARGED TO SHOW DETAIL



1244 CIRCLES



FEATURES & BENEFITS

- Made of mineral fiber (similar material to standard ceiling products)
- Vintage tin ceiling look at an affordable price
- Paintable to match any décor
- Great for covering damaged drywall, plaster or popcorn ceilings

PRODUCT SPECIFICATIONS

| Item # | Edge Detail | Dimensions (Inches) | Install System | Noise Reducing NRC/CAC | Sag Resistance | Mold Resistance | Light Reflectance | Fire Resistance | SF Per Ctn | Pcs/Ctn | Material Type |
|--------|------------------------|---------------------|----------------|------------------------|----------------|-----------------|-------------------|-----------------|------------|---------|---------------|
| 46 | Square Tongue & Groove | 12 x 12 x 1/2 | Easy Up | -/30 | Standard | Standard | 0.76 | Class A | 40 | 40 | Mineral Fiber |
| 1240 | Square Tongue & Groove | 12 x 12 x 1/2 | Easy Up | -/30 | Standard | Standard | 0.80 | Class A | 40 | 40 | Mineral Fiber |
| 1244 | Square Tongue & Groove | 12 x 12 x 1/2 | Easy Up | -/30 | Standard | Standard | 0.80 | Class A | 40 | 40 | Mineral Fiber |

INSTALLATION SYSTEM

- Tongue & groove products have no visible grid
- Easy Up® installation system or adhesive

Click here for additional information

For installation instructions, please visit ceilings.com/installation

Painting will void warranty

12-in x 12-in CEILINGS

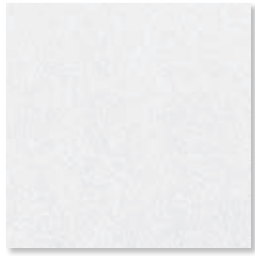

231 WASHABLE WHITE*

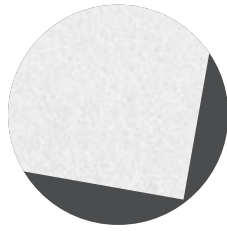

250 PINEHURST™

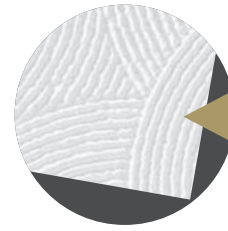

ENLARGED
TO SHOW
DETAIL

















258 GRENOBLE™



FEATURES & BENEFITS

- Paintable to match any décor
- Great for covering damaged drywall, plaster or popcorn ceilings

PRODUCT SPECIFICATIONS

| Item # | Edge Detail | Dimensions (Inches) | Install System | Noise Reducing NRC/CAC | Sag Resistance | Mold Resistance | Light Reflectance | Fire Resistance | SF Per Ctn | Pcs/Ctn | Material Type |
|--------|---|---------------------|----------------|--|--|--|-------------------|---|------------|---------|---------------|
| 231 |  Beveled Tongue & Groove | 12 x 12 x 1/2 | Easy Up |  -/30 |  Standard |  Standard | 0.80 |  Class A | 40 | 40 | Mineral Fiber |
| 250 |  Beveled Tongue & Groove | 12 x 12 x 1/2 | Easy Up |  -/30 |  Standard |  Standard | 0.80 |  Class A | 40 | 40 | Mineral Fiber |
| 258 |  Beveled Tongue & Groove | 12 x 12 x 1/2 | Easy Up |  -/30 |  Standard |  Standard | 0.80 |  Class A | 40 | 40 | Mineral Fiber |

INSTALLATION SYSTEM

- Tongue & groove products have no visible grid
- Easy Up® installation system or adhesive

Click here for additional information

For installation instructions, please visit ceilings.com/installation

Painting will void warranty

**This tile may be cleaned by lightly wiping with a soft, damp cloth, or by using a vacuum hose with a soft brush attachment. Do not scrub, immerse, or soak tiles in water or use soap.*

12-in x 12-in Ceilings



ACOUSTAFFIX®



SURFACE MOUNT CEILING AND WALL PANELS

2012WH ACOUSTAFFIX® WHITE (CEILING)

AcoustAffix®
SURFACE MOUNT CEILING
& WALL PANELS

ACOUSTAFFIX® SURFACE MOUNT CEILING AND WALL PANELS

Control acoustics while maintaining an open, exposed structure design with AcoustAffix® fine-textured panels.

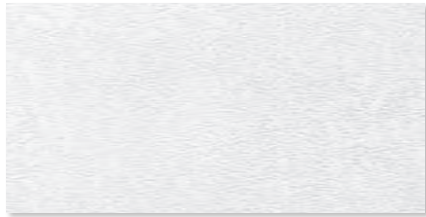

2012WH ACOUSTAFFIX® WHITE

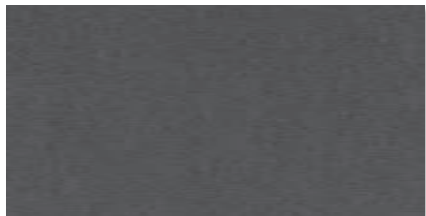
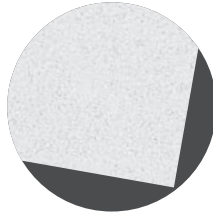

2012BL ACOUSTAFFIX® BLACK

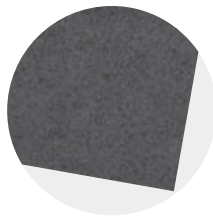

2012 ACOUSTAFFIX® FIELD PAINTABLE

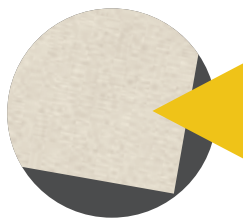

ENLARGED TO SHOW DETAIL

FEATURES & BENEFITS

- Panels install using adhesive, Armstrong All-in-one Self-stop Fastener, or Armstrong Truss Mounting Kit
- Ideal for exposed structure ceilings and walls when traditional suspended ceilings are not desired
- Designed to blend in with the existing deck while providing superior sound absorption (NRC 0.75)
- Mounts directly to structure, screwed into hat track or drywall grid
- Three options available—field paintable, and prefinished black and white
- Prefinished options have a smooth, clean durable finish—scratch-resistant, soil-resistant

PRODUCT SPECIFICATIONS

| Item # | Edge Detail | Dimensions (Inches) | Install System | Noise Reducing NRC/CAC | Sag Resistance | Mold Resistance | Fog | Spray | Wipe | Light Reflectance | Fire Resistance | SF Per Ctn | Pcs/Ctn | Material Type |
|------------------|------------------------|---------------------|----------------|------------------------|----------------|-----------------|-----|-------|------|-------------------|-----------------|------------|---------|---------------|
| 2012 | Square | 24 x 48 x 3/4 | Various | 0.75/- | Superior | Superior | ✓ | - | - | - | Class A | 48 | 6 | Mineral Fiber |
| 2012WH 2012BL | Square/Reverse Tegular | 24 x 48 x 3/4 | Various | 0.75/- | Superior | Superior | ✓ | - | - | - | Class A | 48 | 6 | Mineral Fiber |



2012BL ACOUSTAFFIX® BLACK (CEILING)

AcoustAffix®
SURFACE MOUNT CEILING
& WALL PANELS

ACOUSTAFFIX® PANEL INSTALLATION OPTIONS

1 ALL-IN-ONE SELF-STOP FASTENER IN COORDINATING FINISHES



All-in-one Self-stop Fastener eliminates the need for a separate washer, allowing for a fast installation. A built-in self-stop feature prevents over-driving and damaging the panel. Fastener can be used for both ceiling and wall installations and are available in coordinating finishes: White (2021WH), Black (2021BL), Mill (2021).



▲ Click link to watch video

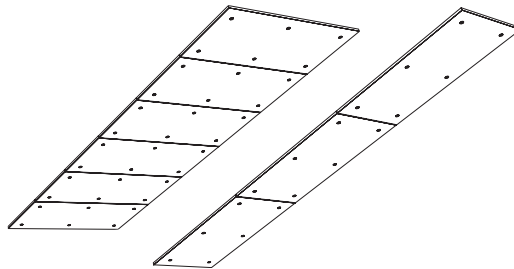

Horizontal Installation: Panels installed with Self-stop Fastener on steel furring channel or drywall grid.

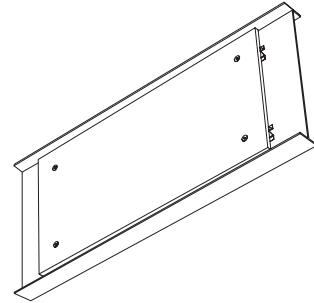

Vertical Installation: Panels installed with Self-stop Fastener on steel furring channel on an I-Beam.

2 TRUSS MOUNTING KIT IN COORDINATING FINISHES



The Truss Mounting Kit includes threaded rods and weld nuts and allows for panel installation on an open truss system. Field modifiable rods will work with a wide range of truss layouts and thicknesses. Available in coordinating finishes: White (2022WH), Black (2022BL), Mill (2022).

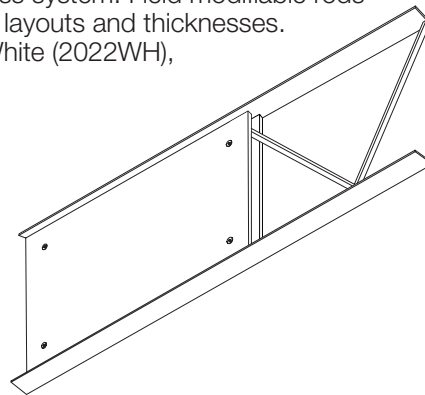

Vertical Installation: Panels (in pairs) installed with Mounting Kit on truss.

3 ADHESIVE



Panels can be adhered to concrete, drywall and plaster with Titebond® GREENchoice Acoustical Ceiling Tile Adhesive. Follow adhesive manufacturer's instructions for application and usage.

Titebond and GREENChoice are trademarks of Franklin International

For full installation instructions (including wall installation) visit ceilings.com/acoustaffix

EXPANDED COMMERCIAL ACCESS BUSINESS OPPORTUNITY

ARMSTRONG® CEILINGS & GRID

PROGRAM INFO:

- Expanded access to stocked commercial products (approximately 6,500 SKUs)
- Axiom® trims and specialty products are included
- Target smaller jobs—under 10,000 sq. ft.
- Visit ceilings.com/dealertools for helpful information (Click here for details)
- For pricing information or questions, contact your distributor

PROGRAM OPPORTUNITIES:

Repair/Replacement

- Target maintenance departments/property managers of schools, government buildings, medical facilities, office complexes, etc.
- Inform contractors and building maintenance staff that a wide range of Armstrong ceiling and grid products can be purchased from you

New construction

- Target smaller jobs—less than 10,000 sq. ft.
- Focus on jobs where general contractor does the work (does not sub-out work)

JOB QUOTES:

The following information is required for job quotes:

- Preferred distributor (include sales rep/branch)
- Job location – City, State, Zip
- Product name(s) or item number(s)
- Square footage or # of pieces of each product
- Job name (if available)
- Product ship date (if available)

COMMERCIAL ACCESS DEALER TOOL KIT

Tools and resources are available at ceilings.com/dealertoolkit to help you close ceiling projects:

- Full listing of Armstrong® ceiling and grid products
- Popular products with data sheets
- Ceiling selector guide
- Retail vs. Commercial crossover reference sheet
- Fire Rated Assemblies vs. Class A Fire Rated info sheet
- Estimating and installation tools
 - Drop Ceiling Calculator and Layout Tool
 - Drywall Grid and Soffit Estimator
 - Installation instructions and videos

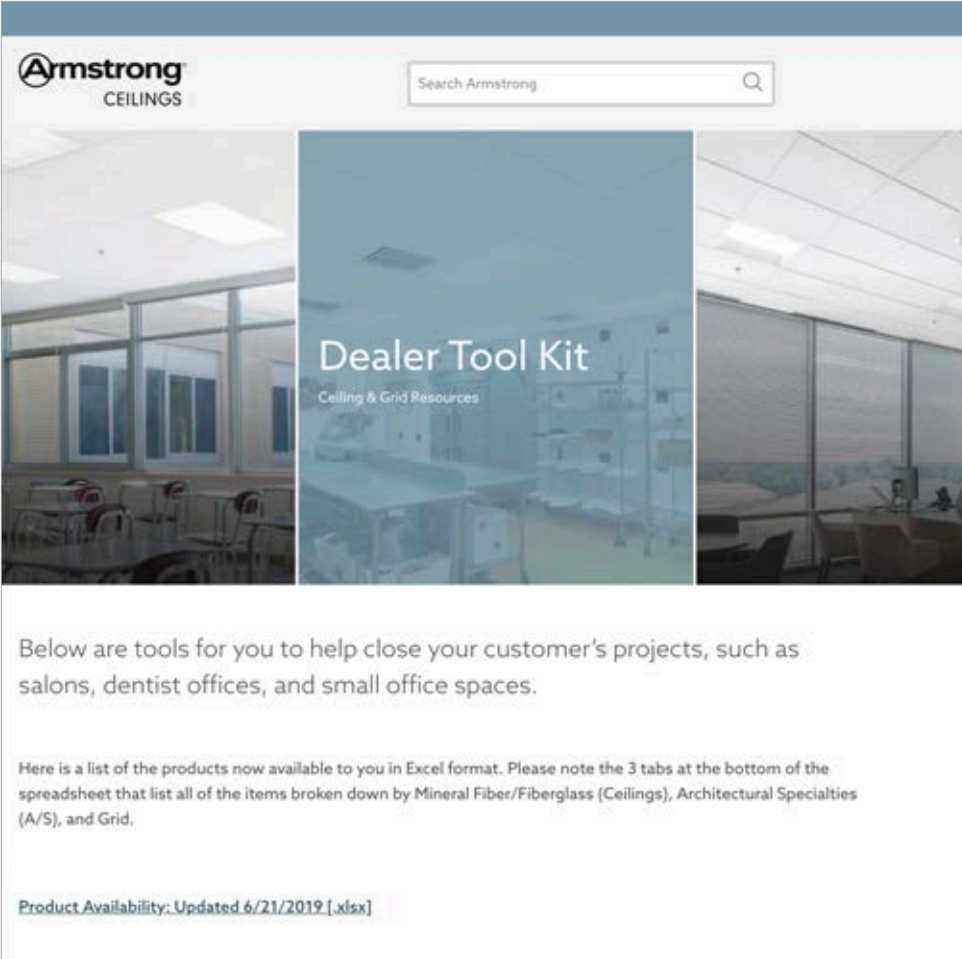

Below are tools for you to help close your customer's projects, such as salons, dentist offices, and small office spaces.

Here is a list of the products now available to you in Excel format. Please note the 3 tabs at the bottom of the spreadsheet that list all of the items broken down by Mineral Fiber/Fiberglass (Ceilings), Architectural Specialties (A/S), and Grid.

[Product Availability: Updated 6/21/2019 \[.xlsx \]](#)

SUSPENDED (DROP) CEILING INSTALLATION

- Need access above your ceiling?
- Have 3-in of headroom to spare?

WHY USE AN ARMSTRONG® SUSPENDED (DROP) CEILING VS DRYWALL?

- Accessibility to pipes, duct work and wiring
- Faster and cleaner installation
- May reduce noise and resist mold/mildew
- Broad selection of visuals
- Easy to repair and replace damaged or stained panels



▲ [Click link to watch video](#)

INSTALLATION



1 Install wall molding



2 Suspend main beams with hanging hardware

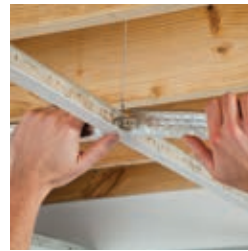

3 Install cross tees



4 Install ceiling panels

PRELUDE® (15/16-in FACE) AND SUPRAFINE® (9/16-in FACE) CEILING SUSPENSION SYSTEMS

- Heavy-duty performance (7301); intermediate-duty performance (Prelude 7300, Suprafine 7500)
- Meets all building codes for residential and non-residential construction
- Easy installation—Choice of stab-in (XL) or hook-in (ML) cross tees; only 3-in clearance required (Prelude only)
- Rotary stitched during manufacture for additional torsional strength and extra stability during installation
- SuperLock™ main beam clip is engineered for a strong, secure connection and fast, accurate alignment confirmed with audible click; easy to remove/relocate
- Hot-dipped galvanized coating inhibits red rusting better than electrogalvanized or painted systems
- 10-year limited warranty; 30-year with Armstrong® high-performance ceiling panels

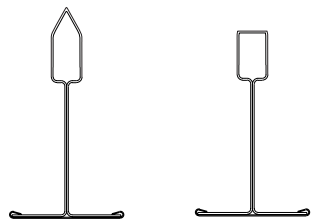

PeakForm®

Square Bulb



15/16-in grid



9/16-in grid

PeakForm® profile increases strength and stability for improved performance during installation

PeakForm products (cross tees and main beams) offer a superior load-carrying capacity than typical square bulb



Fire Guard™ product options for UL design fire-rated performance only

Expansion Relief on Fire Guard™ Main Beam

QUICKHANG™ GRID HOOK AND INSTALLATION KITS

QUICKHANG™
grid hook and installation kits

INSTALLATION



SUSPENDED (DROP) CEILING

QUICKHANG GRID HOOK KITS

QuickHang™ hooks and brackets offer a new way to install a basement drop ceiling system directly to joists more quickly and easily than with hanger wire. The QuickHang system is available in two new accessory kits with different length hooks.



PRODUCT SPECIFICATIONS

| Item # | Product Name | Length (Inches) | Kits/Ctn | Components/ Individual Kits | SF Per Ctn* |
|--------|--|-----------------|------------------|-----------------------------------|--------------------------|
| 6366 | QuickHang 6" Grid Hook Kits – Master Carton | 6" Hook | Includes 12 Kits | 6 Hooks 6 Brackets 20 Nails | (160 per individual kit) |
| 6367 | QuickHang 6" Grid Hook Kit – Individual Kit | 6" Hook | N/A | 6 Hooks 6 Brackets 20 Nails | (160 per individual kit) |
| 6368 | QuickHang 12" Grid Hook Kits – Master Carton | 12" Hook | Includes 12 Kits | 6 Hooks 6 Brackets 20 Nails | (160 per individual kit) |
| 6369 | QuickHang 12" Grid Hook Kit – Individual Kit | 12" Hook | N/A | 6 Hooks 6 Brackets 20 Nails | (160 per individual kit) |

*Based on a 10' x 16' room; for residential use only

BENEFITS

- Use with standard grid
- Attach drop ceiling grid to joists
- Save time – faster than hanger wire
- Easily level a grid system
- Minimize drop (less than 3-in); maximize headroom
- Avoid obstructions by using kits with 12" hooks

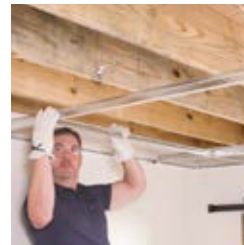

▲ Click link to watch video

INSTALLATION STEPS:

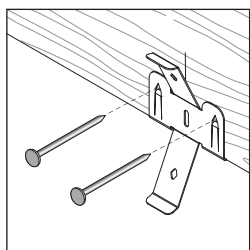

1 Attach bracket to joist using hammer tabs & nails

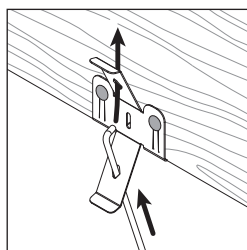

2 Insert hook into bracket

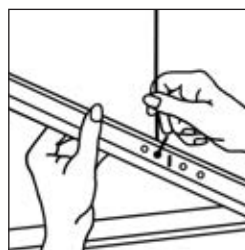

3 Hang grid main beam on hook

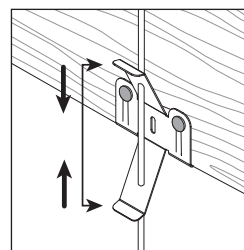

4 Level grid by squeezing tabs & moving hook up or down

For full instructions and estimating guide, please visit ceilings.com/quickhang

QUICKHANG™ INSTALLATION KITS (FORMERLY PRELUDE® INSTALLATION KITS)



The new QuickHang™ installation kits have everything you need to install 64 sq. ft. of a 2' x 2' or 2' x 4' drop ceiling. These kits include the new QuickHang hooks and brackets and replace existing grid kits.

- **6362WH**—2' x 2' QuickHang Installation Kit (White)
- **6362BL**—2' x 2' QuickHang Installation Kit (Black)
- **6364WH**—2' x 4' QuickHang Installation Kit (White)



BENEFITS

- Convenient all-in-one kits
- Perfect for dealers with consumer traffic
- Easier installs for contractors and homeowners

INSTALL YOUR GRID SYSTEM IN 4 EASY STEPS

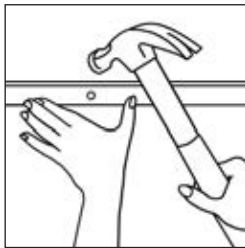

1 Install wall molding

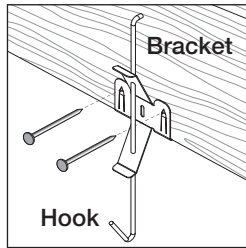

2 Attach QuickHang™ bracket to joist and insert hook

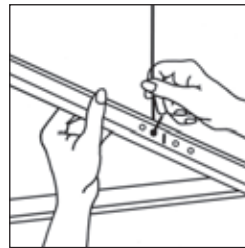

3 Hang main beams on hooks

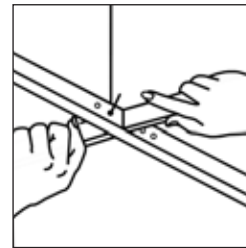

4 Install cross tees and level by adjusting hooks



▲ [Click link to watch video](#)

| 2' x 2' White | 2' x 2' Black | 2' x 4' White | |
|--|--|--|---------------|
| Kit Includes: 3 – 72-in Prelude® Main Beams 9 – 48-in Cross Tees 9 – 24-in Cross Tees 6 – 72-in Wall Moldings 6 – 12-in QuickHang™ Hooks 6 – Joist Brackets 40 – Nails | Kit Includes: 3 – 72-in Prelude® Main Beams 9 – 48-in Cross Tees 9 – 24-in Cross Tees 6 – 72-in Wall Moldings 6 – 12-in QuickHang™ Hooks 6 – Joist Brackets 40 – Nails | Kit Includes: 3 – 72-in Prelude® Main Beams 9 – 48-in Cross Tees 6 – 72-in Wall Moldings 6 – 12-in QuickHang™ Hooks 6 – Joist Brackets 40 – Nails | |
| Panel Size | 24-in x 24-in | 24-in x 24-in | 24-in x 48-in |
| Kit Number | 6362WH | 6362BL | 6364WH |
| Approx. Wt./Ctn. (lbs.) | 15 | 15 | 13 |
| Ctns. per Pallet | 48 | 48 | 48 |

Please visit ceilings.com/projectestimator to access our online material estimator for ceiling panels.

For a QuickHang installation kit estimating guide, please visit ceilings.com/quickhangguide

SUSPENDED (DROP) CEILING INSTALLATION SYSTEMS



Suspension systems for your ceiling project have different requirements depending on the space and its intended usage. If you are unsure of your requirements, check with your local building code official. Based on your needs, simply select your color (white or black); tile size (only 2-ft x 2-ft layout requires 2-ft cross tee); and end detail (XL®—staked on clip for secure locked connection with overlap for stability or ML—hook-on end detail, butt-edge detail, easier to remove).

Intermediate Duty—Prelude® 15/16-in Grid System

| Cross Section Illustration | Prelude Item# | Product Name | Color | LBS/LF on 4 span | Length | Web Height | Flange Width | PC/CTN | LF/CTN |
|----------------------------|---------------|--|-------|------------------|--------|------------|--------------|--|--------|
| | 7300 | 12-ft Intermediate Duty Main Beam | White | 12.8 | 144-in | 1 11/16-in | 15/16-in | 20 | 240 |
| | 7301BL | 12-ft Heavy Duty Main Beam | Black | 12.8 | 144-in | 1 11/16-in | 15/16-in | 20 | 240 |
| | XL7342BL | 4-ft Stab Cross Tee | Black | | 48-in | 1 1/2-in | 15/16-in | 60 | 240 |
| | XL7348RWH | 4-ft Stab Cross Tee | White | | 48-in | 1 3/8-in | 15/16-in | 60 | 240 |
| | XL7328RWH | 2-ft Stab Cross Tee | White | | 24-in | 1 3/8-in | 15/16-in | 60 | 120 |
| | XL7328BL | 2-ft Stab Cross Tee | Black | | 24-in | 1 3/8-in | 15/16-in | 60 | 120 |
| | ML7343 | 4-ft Hook Cross Tee | White | | 48-in | 1 1/2-in | 15/16-in | 60 | 240 |
| | ML7343BL | 4-ft Hook Cross Tee | Black | | 48-in | 1 1/2-in | 15/16-in | 60 | 240 |
| | ML7323 | 2-ft Hook Cross Tee | White | | 24-in | 1 1/2-in | 15/16-in | 60 | 120 |
| | ML7323BL | 2-ft Hook Cross Tee | Black | | 24-in | 1 1/2-in | 15/16-in | 60 | 120 |
| | 7800RWH | 12-ft Wall Molding | White | | 144-in | 7/8-in | 7/8-in | 30 | 360 |
| | 7800BL | 12-ft Wall Molding | Black | | 144-in | 7/8-in | 7/8-in | 30 | 360 |
| | 6366A | QuickHang™ 6" Grid Hook Kits – Master Cartons <i>*For residential use only</i> | — | | | | | Click here for details | |
| | 6368A | QuickHang™ 12" Grid Hook Kits – Master Cartons <i>*For residential use only</i> | — | | | | | Click here for details | |
| | 7891 | 12 Gauge Hanger Wire | | | 144-in | | | 140 | |

UL Fire-Rated Assembly—Prelude® 15/16-in Grid System

NOTE: use with 915 Textured FIRE GUARD™ Ceiling Panels

For use in spaces in which an hourly rating is needed to meet code requirements.

| Cross Section Illustration | Prelude Item# | Product Name | Color | LBS/LF on 4-ft span | Length | Web Height | Flange Width | PC/CTN | LF/CTN |
|----------------------------|---------------|---|-------|---------------------|--------|------------|--------------|--------|--------|
| | 8300XRWH | Fire Guard™ 12-ft Intermediate Duty Main Beam | White | 12.8 | 144-in | 1 11/16-in | 15/16-in | 20 | 240 |
| | 8300BL | Fire Guard™ 12-ft Intermediate Duty Main Beam | Black | 12.8 | 144-in | 1 11/16-in | 15/16-in | 20 | 240 |
| | XL8340RWH | 4-ft Stab Cross Tee | White | | 48-in | 1 11/16-in | 15/16-in | 60 | 240 |
| | XL8340BL | 4-ft Stab Cross Tee | Black | | 48-in | 1 11/16-in | 15/16-in | 60 | 240 |
| | XL8323RWH | 2-ft Stab Cross Tee | White | | 24-in | 1 3/8-in | 15/16-in | 60 | 120 |
| | XL8323BL | 2-ft Stab Cross Tee | Black | | 24-in | 1 3/8-in | 15/16-in | 60 | 120 |
| | 7800RWH | 12-ft Wall Molding | White | | 144-in | 7/8-in | 7/8-in | 30 | 360 |
| | 7800BL | 12-ft Wall Molding | Black | | 144-in | 7/8-in | 7/8-in | 30 | 360 |
| | 7891 | 12 Gauge Hanger Wire | | | 144-in | | | 140 | |

NOTE: Must be installed according to directions and no product substitutions.



Heavy Duty—Prelude® 15/16-in Grid System

| Cross Section Illustration | Prelude Item# | Product Name | Color | LBS/LF on 4-ft span | Length | Web Height | Flange Width | PC/CTN | LF/CTN |
|----------------------------|---------------|----------------------------|-------|---------------------|--------|------------|--------------|--------|--------|
| | 7301WH | 12-ft Heavy Duty Main Beam | White | 16.5 | 144-in | 1 11/16-in | 15/16-in | 20 | 240 |
| | 7301BL | 12-ft Heavy Duty Main Beam | Black | 16.5 | 144-in | 1 11/16-in | 15/16-in | 20 | 240 |
| | XL7342BL | 4-ft Stab Cross Tee | Black | | 48-in | 1 1/2-in | 15/16-in | 60 | 240 |
| | XL7348RWH | 4-ft Stab Cross Tee | White | | 48-in | 1 3/8-in | 15/16-in | 60 | 240 |
| | XL7328RWH | 2-ft Stab Cross Tee | White | | 24-in | 1 3/8-in | 15/16-in | 60 | 120 |
| | XL7328BL | 2-ft Stab Cross Tee | Black | | 24-in | 1 3/8-in | 15/16-in | 60 | 120 |
| | ML7343WH | 4-ft Hook Cross Tee | White | | 48-in | 1 1/2-in | 15/16-in | 60 | 240 |
| | ML7343BL | 4-ft Hook Cross Tee | Black | | 48-in | 1 1/2-in | 15/16-in | 60 | 240 |
| | ML7323WH | 2-ft Hook Cross Tee | White | | 24-in | 1 1/2-in | 15/16-in | 60 | 120 |
| | ML7323BL | 2-ft Hook Cross Tee | Black | | 24-in | 1 1/2-in | 15/16-in | 60 | 120 |
| | 7800RWH | 12-ft Wall Molding | White | | 144-in | 7/8-in | 7/8-in | 30 | 360 |
| | 7800BL | 12-ft Wall Molding | Black | | 144-in | 7/8-in | 7/8-in | 30 | 360 |
| | 7891 | 12 Gauge Hanger Wire | | | 144-in | | | 140 | |

Suprafine® 9/16-in Grid System

| Cross Section Illustration | Accessories Item# | Accessories Name | Color | LBS/LF on 4-ft span | Length | Web Height | Flange Width | PC/CTN | LF/CTN |
|----------------------------|-------------------|--|-------|---------------------|--------|------------|--------------|------------------------|--------|
| | 7500RWH | 12-ft Intermediate Duty Main Beam | White | 12.75 | 144-in | 1 11/16-in | 9/16-in | 20 | 240 |
| | XL7540RWH | 4-ft Stab Cross Tee | White | | 48-in | 1 11/16-in | 9/16-in | 60 | 240 |
| | XL7520RWH | 2-ft Stab Cross Tee | White | | 24-in | 1 11/16-in | 9/16-in | 60 | 120 |
| | 7804RWH | 12-ft Wall Molding | White | | 144-in | 7/8-in | 9/16-in | 30 | 360 |
| | 6366A | QuickHang™ 6" Grid Hook Kits – Master Cartons <i>*For residential use only</i> | — | | | | | Click here for details | |
| | 6368A | QuickHang™ 12" Grid Hook Kits – Master Cartons <i>*For residential use only</i> | — | | | | | Click here for details | |
| | 7891 | 12 Gauge Hanger Wire | | | 144-in | | | 140 | |

SUSPENDED (DROP) CEILING INSTALLATION SYSTEMS ACCESSORIES

Clips help with installations, making transitions easier, aiding with squareness, and ensuring building requirements are met.

Prelude® 15/16-in Grid System Accessories

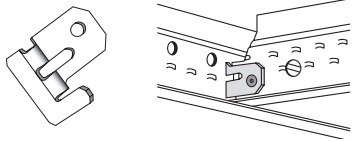
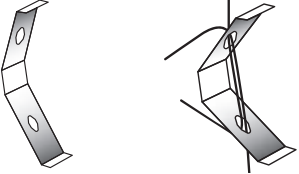
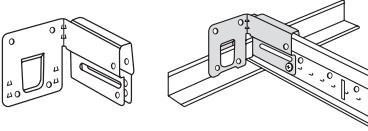
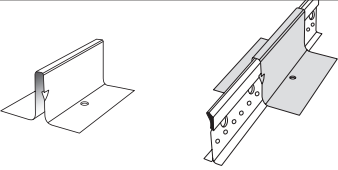
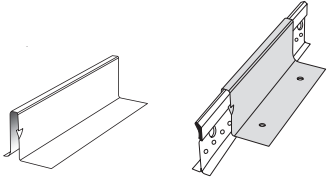
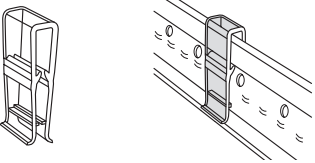
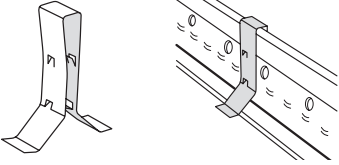
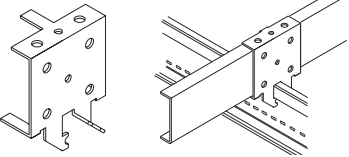
| Cross Section Illustration | Item# | Product Name | Weight (lbs) per carton | PC/CTN |
|---|-----------|---|-------------------------|--------|
|  | FZSTAC | Single Tee Adapter Clip | 1.50 | 50 |
|  | FZWS12A | Wire Splice | 1.00 | 50 |
|  | FZBERC2 | 2-in Beam End Retaining Clip | 5.00 | 50 |
| | BERC2 | 2-in Beam End Retaining Clip | 34.00 | 200 |
|  | MBACAG | Main Beam Adapter Clip | 11.00 | 70 |
|  | FZDWACSAG | Drywall Attachment Clip | 4.00 | 50 |
|  | FZCHDC | Clear Hold Down Clip <i>(Recommended for use with Easy Elegance™ ceiling panels)</i> | 0.50 | 50 |
|  | FZUHDCA | Universal Hold Down Clip | 0.50 | 50 |
| | UHDCA | Universal Hold Down Clip | 9.00 | 1000 |
|  | UTCA | Up Tight Clip (to attach to wood joist) | 16.00 | 250 |



SUSPENDED CEILING ESTIMATING GUIDE

FOR CEILING PANELS AND GRID



Main beams parallel to room's short dimension. Main beams parallel to room's long dimension.

Instructions: Find room size on left and read across for 24-in x 24-in or 24-in x 48-in ceiling panels. As a general rule, use one, two-bulb 4-ft fluorescent lighting fixture every 75 square feet. Use one luminous panel for every recessed lighting fixture.

| ROOM SIZE | | | 24-in x 24-in | | | | | | 24-in x 48-in | | | | ROOM SIZE | | | 24-in x 24-in | | | | | | 24-in x 48-in | | | | | | | |
|---|-----|----|----------------------|------------------|-----------------|-----------------|------------------|-----------------|----------------------|------------------|------------------|-----------------|---|-----------------|-----------|----------------------|----------------------|------------------|------------------|-----------------|-----------------|----------------------|-----------------|-----------------|------------------|------------------|-----------------|------------------|-----------------|
| AREA - SQ FT | | | NUMBER OF PANELS | 12-ft MAIN BEAMS | 4-ft CROSS TEES | 2-ft CROSS TEES | 12-ft MAIN BEAMS | 4-ft CROSS TEES | 2-ft CROSS TEES | NUMBER OF PANELS | 12-ft MAIN BEAMS | 4-ft CROSS TEES | 12-ft MAIN BEAMS | 4-ft CROSS TEES | ROOM SIZE | AREA - SQ FT | 12-ft WALL MOULDINGS | NUMBER OF PANELS | 12-ft MAIN BEAMS | 4-ft CROSS TEES | 2-ft CROSS TEES | 12-ft MAIN BEAMS | 4-ft CROSS TEES | 2-ft CROSS TEES | NUMBER OF PANELS | 12-ft MAIN BEAMS | 4-ft CROSS TEES | 12-ft MAIN BEAMS | 4-ft CROSS TEES |
| 12-ft WALL MOULDINGS | | | 12-ft WALL MOULDINGS | | | | | | 12-ft WALL MOULDINGS | | | | 12-ft WALL MOULDINGS | | | 12-ft WALL MOULDINGS | | | | | | 12-ft WALL MOULDINGS | | | | | | | |
| 6-ft x 6-ft to 10-ft x 48-ft Room Sizes | | | | | | | | | | | | | 12-ft x 12-ft to 20-ft x 24-ft Room Sizes | | | | | | | | | | | | | | | | |
| 6 x 6 | 36 | 2 | 9 | 1 | 2 | 5 | 1 | 2 | 5 | 6 | 1 | 4 | 1 | 4 | 12 x 12 | 144 | 4 | 36 | 2 | 15 | 18 | 2 | 15 | 18 | 18 | 2 | 15 | 2 | 15 |
| 6 x 8 | 48 | 3 | 12 | 1 | 4 | 6 | 1 | 3 | 7 | 8 | 1 | 6 | 1 | 6 | 12 x 14 | 168 | 5 | 42 | 3 | 15 | 23 | 3 | 18 | 21 | 21 | 3 | 17 | 3 | 18 |
| 6 x 10 | 60 | 3 | 15 | 1 | 4 | 8 | 1 | 4 | 9 | 10 | 1 | 7 | 1 | 8 | 12 x 16 | 192 | 5 | 48 | 3 | 20 | 24 | 3 | 21 | 24 | 24 | 3 | 20 | 3 | 21 |
| 6 x 12 | 72 | 3 | 18 | 1 | 6 | 9 | 1 | 5 | 11 | 12 | 1 | 9 | 1 | 10 | 12 x 18 | 216 | 5 | 54 | 4 | 20 | 29 | 3 | 24 | 27 | 27 | 4 | 22 | 3 | 24 |
| 6 x 14 | 84 | 4 | 21 | 2 | 6 | 11 | 2 | 6 | 13 | 14 | 2 | 10 | 2 | 12 | 12 x 20 | 240 | 6 | 60 | 4 | 25 | 30 | 4 | 27 | 30 | 30 | 4 | 25 | 4 | 27 |
| 6 x 18 | 108 | 4 | 27 | 2 | 8 | 14 | 2 | 8 | 17 | 18 | 2 | 13 | 2 | 16 | 12 x 24 | 288 | 6 | 72 | 5 | 30 | 36 | 4 | 33 | 36 | 36 | 5 | 30 | 4 | 33 |
| 6 x 22 | 132 | 5 | 33 | 3 | 10 | 17 | 2 | 10 | 21 | 22 | 3 | 16 | 2 | 20 | 12 x 28 | 336 | 7 | 84 | 6 | 35 | 42 | 5 | 39 | 42 | 42 | 6 | 35 | 5 | 39 |
| 6 x 26 | 156 | 6 | 39 | 3 | 12 | 20 | 3 | 12 | 25 | 26 | 3 | 19 | 3 | 24 | 12 x 32 | 384 | 8 | 96 | 7 | 40 | 48 | 6 | 45 | 48 | 48 | 7 | 40 | 6 | 45 |
| 6 x 30 | 180 | 6 | 45 | 4 | 14 | 23 | 3 | 14 | 29 | 30 | 4 | 22 | 3 | 28 | 12 x 36 | 432 | 8 | 108 | 8 | 45 | 54 | 6 | 51 | 54 | 54 | 8 | 45 | 6 | 51 |
| 6 x 34 | 204 | 7 | 51 | 4 | 16 | 26 | 3 | 16 | 33 | 34 | 4 | 25 | 3 | 32 | 12 x 40 | 480 | 9 | 120 | 9 | 50 | 60 | 7 | 57 | 60 | 60 | 9 | 50 | 7 | 57 |
| 6 x 38 | 228 | 8 | 57 | 5 | 18 | 29 | 4 | 18 | 37 | 38 | 5 | 28 | 4 | 36 | 12 x 44 | 528 | 10 | 132 | 10 | 55 | 66 | 8 | 63 | 66 | 66 | 10 | 55 | 8 | 63 |
| 6 x 42 | 252 | 8 | 63 | 5 | 20 | 32 | 4 | 20 | 41 | 42 | 5 | 31 | 4 | 40 | 12 x 48 | 576 | 10 | 144 | 11 | 60 | 72 | 8 | 69 | 72 | 72 | 11 | 60 | 8 | 69 |
| 6 x 46 | 276 | 9 | 69 | 6 | 22 | 35 | 4 | 22 | 45 | 46 | 6 | 34 | 4 | 44 | 12 x 50 | 600 | 11 | 150 | 12 | 60 | 77 | 9 | 72 | 75 | 75 | 12 | 62 | 9 | 72 |
| 6 x 50 | 300 | 10 | 75 | 6 | 24 | 38 | 5 | 24 | 49 | 50 | 6 | 37 | 5 | 48 | 14 x 14 | 196 | 5 | 56 | 4 | 18 | 27 | 4 | 18 | 27 | 28 | 4 | 24 | 4 | 24 |
| 8 x 8 | 64 | 3 | 16 | 1 | 6 | 8 | 1 | 6 | 8 | 8 | 1 | 6 | 1 | 6 | 14 x 16 | 224 | 5 | 63 | 4 | 18 | 28 | 4 | 21 | 31 | 32 | 4 | 28 | 4 | 28 |
| 8 x 10 | 80 | 3 | 20 | 2 | 6 | 11 | 1 | 8 | 10 | 10 | 2 | 7 | 1 | 8 | 14 x 18 | 252 | 6 | 70 | 5 | 24 | 34 | 5 | 24 | 35 | 36 | 5 | 31 | 5 | 32 |
| 8 x 12 | 96 | 4 | 24 | 2 | 9 | 12 | 1 | 10 | 12 | 12 | 2 | 9 | 1 | 10 | 14 x 20 | 280 | 6 | 77 | 5 | 24 | 35 | 5 | 27 | 39 | 40 | 5 | 35 | 5 | 36 |
| 8 x 14 | 112 | 4 | 28 | 2 | 9 | 15 | 2 | 12 | 14 | 14 | 2 | 10 | 2 | 12 | 14 x 22 | 308 | 6 | 84 | 6 | 30 | 41 | 6 | 31 | 43 | 44 | 6 | 38 | 6 | 40 |
| 8 x 16 | 128 | 4 | 32 | 2 | 12 | 16 | 2 | 14 | 16 | 16 | 2 | 12 | 2 | 14 | 14 x 26 | 364 | 7 | 98 | 7 | 36 | 48 | 7 | 37 | 51 | 52 | 7 | 45 | 7 | 48 |
| 8 x 18 | 144 | 5 | 36 | 3 | 12 | 19 | 2 | 16 | 18 | 18 | 3 | 13 | 2 | 16 | 14 x 30 | 420 | 8 | 112 | 9 | 42 | 55 | 8 | 43 | 59 | 60 | 9 | 52 | 8 | 56 |
| 8 x 20 | 160 | 5 | 40 | 3 | 15 | 20 | 2 | 18 | 20 | 20 | 3 | 15 | 2 | 18 | 14 x 34 | 476 | 8 | 126 | 10 | 48 | 62 | 9 | 49 | 67 | 68 | 10 | 59 | 9 | 64 |
| 8 x 22 | 176 | 5 | 44 | 4 | 15 | 23 | 2 | 20 | 22 | 22 | 4 | 16 | 2 | 20 | 14 x 38 | 532 | 9 | 140 | 11 | 54 | 69 | 10 | 55 | 75 | 76 | 11 | 66 | 10 | 72 |
| 8 x 26 | 208 | 6 | 52 | 4 | 18 | 27 | 3 | 24 | 26 | 26 | 4 | 19 | 3 | 24 | 14 x 42 | 588 | 10 | 154 | 12 | 60 | 76 | 11 | 61 | 83 | 84 | 12 | 74 | 11 | 80 |
| 8 x 30 | 240 | 7 | 60 | 5 | 21 | 31 | 3 | 28 | 30 | 30 | 5 | 22 | 3 | 28 | 14 x 46 | 644 | 10 | 168 | 13 | 66 | 83 | 12 | 67 | 91 | 92 | 13 | 81 | 12 | 88 |
| 8 x 34 | 272 | 7 | 68 | 6 | 24 | 35 | 3 | 32 | 34 | 34 | 6 | 25 | 3 | 32 | 14 x 50 | 700 | 11 | 182 | 14 | 72 | 90 | 13 | 73 | 99 | 100 | 14 | 88 | 13 | 96 |
| 8 x 38 | 304 | 8 | 76 | 6 | 27 | 39 | 4 | 36 | 38 | 38 | 6 | 28 | 4 | 36 | 16 x 18 | 288 | 6 | 72 | 6 | 28 | 39 | 5 | 36 | 40 | 36 | 6 | 31 | 5 | 32 |
| 8 x 42 | 336 | 9 | 84 | 7 | 30 | 43 | 4 | 40 | 42 | 42 | 7 | 31 | 4 | 40 | 16 x 22 | 352 | 7 | 88 | 7 | 35 | 47 | 6 | 44 | 48 | 44 | 7 | 38 | 6 | 40 |
| 8 x 46 | 368 | 9 | 92 | 8 | 33 | 47 | 4 | 44 | 46 | 46 | 8 | 34 | 4 | 44 | 16 x 26 | 416 | 7 | 104 | 8 | 42 | 55 | 7 | 52 | 56 | 52 | 8 | 45 | 7 | 48 |
| 8 x 50 | 400 | 10 | 100 | 8 | 36 | 51 | 5 | 48 | 50 | 50 | 8 | 37 | 5 | 48 | 16 x 30 | 480 | 8 | 120 | 10 | 49 | 63 | 8 | 60 | 64 | 60 | 10 | 52 | 8 | 56 |
| 10 x 10 | 100 | 4 | 25 | 2 | 8 | 14 | 2 | 8 | 14 | 15 | 2 | 12 | 2 | 12 | 16 x 34 | 544 | 9 | 136 | 11 | 56 | 71 | 9 | 68 | 72 | 68 | 11 | 59 | 9 | 64 |
| 10 x 12 | 120 | 4 | 30 | 2 | 12 | 15 | 2 | 10 | 17 | 18 | 2 | 15 | 2 | 15 | 16 x 38 | 608 | 9 | 152 | 12 | 63 | 79 | 10 | 76 | 80 | 76 | 12 | 66 | 10 | 72 |
| 10 x 14 | 140 | 4 | 35 | 3 | 12 | 19 | 3 | 12 | 20 | 21 | 3 | 17 | 3 | 18 | 16 x 42 | 672 | 10 | 168 | 14 | 70 | 87 | 11 | 84 | 88 | 84 | 14 | 74 | 11 | 80 |
| 10 x 16 | 160 | 5 | 40 | 3 | 16 | 20 | 3 | 14 | 23 | 24 | 3 | 20 | 3 | 21 | 16 x 46 | 736 | 11 | 184 | 15 | 77 | 95 | 12 | 92 | 96 | 92 | 15 | 81 | 12 | 88 |
| 10 x 18 | 180 | 5 | 45 | 4 | 16 | 24 | 3 | 16 | 26 | 27 | 4 | 22 | 3 | 24 | 16 x 50 | 800 | 11 | 200 | 16 | 84 | 103 | 13 | 100 | 104 | 100 | 16 | 88 | 13 | 96 |
| 10 x 20 | 200 | 5 | 50 | 4 | 20 | 25 | 4 | 18 | 29 | 30 | 4 | 25 | 4 | 27 | 18 x 20 | 360 | 7 | 90 | 6 | 32 | 45 | 7 | 36 | 49 | 50 | 6 | 45 | 7 | 45 |
| 10 x 22 | 220 | 6 | 55 | 5 | 20 | 29 | 4 | 20 | 32 | 33 | 5 | 27 | 4 | 30 | 18 x 24 | 432 | 7 | 108 | 8 | 40 | 54 | 8 | 44 | 59 | 60 | 8 | 54 | 8 | 55 |
| 10 x 24 | 240 | 6 | 60 | 5 | 24 | 30 | 4 | 22 | 35 | 36 | 5 | 30 | 4 | 33 | 18 x 28 | 504 | 8 | 126 | 9 | 48 | 63 | 10 | 52 | 69 | 70 | 9 | 63 | 10 | 65 |
| 10 x 26 | 260 | 6 | 65 | 5 | 24 | 34 | 5 | 24 | 38 | 39 | 5 | 32 | 5 | 36 | 18 x 32 | 576 | 9 | 144 | 11 | 56 | 72 | 11 | 60 | 79 | 80 | 11 | 72 | 11 | 75 |
| 10 x 28 | 280 | 7 | 70 | 5 | 28 | 35 | 5 | 26 | 41 | 42 | 5 | 35 | 5 | 39 | 18 x 36 | 648 | 9 | 162 | 12 | 64 | 81 | 12 | 68 | 89 | 90 | 12 | 81 | 12 | 85 |
| 10 x 32 | 320 | 7 | 80 | 6 | 32 | 40 | 6 | 30 | 47 | 48 | 6 | 40 | 6 | 45 | 18 x 40 | 720 | 10 | 180 | 14 | 72 | 90 | 14 | 76 | 99 | 100 | 14 | 90 | 14 | 95 |
| 10 x 36 | 360 | 8 | 90 | 7 | 36 | 45 | 6 | 34 | 53 | 54 | 7 | 45 | 6 | 51 | 18 x 44 | 792 | 11 | 198 | 15 | 80 | 99 | 15 | 84 | 109 | 110 | 15 | 99 | 15 | 105 |
| 10 x 40 | 400 | 9 | 100 | 8 | 40 | 50 | 7 | 38 | 59 | 60 | 8 | 50 | 7 | 57 | 18 x 48 | 864 | 11 | 216 | 17 | 88 | 108 | 16 | 92 | 119 | 120 | 17 | 108 | 16 | 115 |
| 10 x 44 | 440 | 9 | 110 | 9 | 44 | 55 | 8 | 42 | 65 | 66 | 9 | 55 | 8 | 63 | 20 x 20 | 400 | 7 | 100 | 7 | 45 | 50 | 7 | 45 | 50 | 50 | 7 | 45 | 7 | 45 |
| 10 x 48 | 480 | 10 | 120 | 10 | 48 | 64 | 8 | 46 | 71 | 72 | 10 | 60 | 8 | 69 | 20 x 24 | 480 | 8 | 120 | 9 | 54 | 60 | 8 | 55 | 60 | 60 | 9 | 54 | 8 | 55 |

For an online estimator and calculator, please visit ceilings.com/projectestimator and ceilings.com/calculator



BASEMENT APPLICATIONS

International Residential Code Floor I-Joist Fire Safety

In the last twenty years, engineered I-joist floor systems have grown in popularity over real wood. In UL tests, however, the engineered wooden I-beams only withstood the fire test for 6 minutes versus traditionally constructed floor systems that would last 18 minutes.*

The original International Residential Code R501.3 (I-joist safety code) called for sprinklers installed in a basement. Not many states adopted this into local code. The 2012 version (R501.3) and 2015 version (R302.13) were updated to allow instead for a membrane of either 1/2-inch gypsum wallboard, 5/8-inch wood structural panel membrane (plywood), or the EQUIVALENT to be attached to the underside of the joists, if sprinklers or 2-ft x 10-ft dimensional lumber are not in place.

Many states are now adopting this new version of the Floor Fire Safety code into their local codes. Pennsylvania, Massachusetts, and Ohio, for example, have already adopted versions of the Floor Fire Safety code. Check your local code requirements.



Armstrong® ceilings
provide additional
minutes of protection**

ARMSTRONG CEILINGS SAFE AND SOUND SOLUTION

Armstrong Ceilings has a safe and attractive solution that performs better than the recommended gypsum or plywood membranes. When tested side by side with the IRC R501.3 recommended solution, our grid and ceiling panel solution lasted 60% longer.**

* UL study, Report on Structural Stability of Engineered Lumber in Fire Conditions

**Large-scale comparative test based on ASTM E119, 4/8/13 (contact techline@armstrongceilings.com for test report)

Armstrong® Prelude® Main Beams with the fire relief notch (Item 8300) installed with HumiGuard® Plus acoustical ceiling panels withstood the ASTM E119 fire test for 23 minutes and 40 seconds versus the 14 minutes and 47 seconds for the plywood installation!



Main beam under normal conditions



Main beam exposed to fire



▲ Click link to watch video

WHAT TO ORDER TO COMPLETE YOUR ARMSTRONG SAFE AND SOUND CEILING

1. Grid System: Prelude® Fire Rated Main Beams (8300), standard Cross Tees and Wall Molding
2. Ceiling Panel Options: 241 SuperTuff™, 269 Sand Pebble™, 271 Sahara™, 273 Sahara™, 490 Yuma White®, 491 Yuma White®, 492 Yuma White®, 493 Yuma White®, 915 Textured FIRE GUARD™, 922 Fine Fissured™, 928 Fine Fissured™, 932 Fine Fissured™, 954 Classic Fine Textured, 973 Lumawash®, 9768 Sahara™ Scored II*, 9769 Sahara™ Scored I* and 1728BL Fine Fissured™ Black

*New products EQUIVALENT to HumiGuard® Plus ceilings listed in report, but not included in the evaluation.

CLASS A VS. FIRE RATED PANELS

CLASS A (LOW FLAME SPREAD) PANELS

A Class A, or low flame spread, ceiling panel means that the panel is not impacted when the surface is exposed to a flame. It doesn't appear to burn and doesn't add to the fire. It will not help spread the fire.

Class A ceilings meet the interior finish requirements of both the International Building Code and the Residential Building code.

Nearly all Armstrong® ceiling panels meet Class A standards (flame spread rating of 25 or less.)

FIRE RATED PANELS

Local building codes, which require fire-safe construction for many building applications, rely on 2 ratings to evaluate compliance:

1. Flame spread rating of material
2. Fire resistance rating of a construction assembly

A fire rated panel looks at the performance of a panel once the entire building or space is burning. In this case, the concern is about protecting the entire building. Reviewers look at the ceiling panels, grid and the construction of the building itself, and the output is a fire resistance time rating. Components include ceilings, grid lights, subfloor, deck, joists, lights, air supply, etc.

New construction may include sprinklers. These typically reduce the need for time-rated fire assemblies. Only a small percentage of spaces require fire-rated ceiling panels (Fire Guard).

**If you have questions related to Class A or fire rated panels, please contact Techline:
techline@armstrongceilings.com • 1-877-ARMSTRONG**

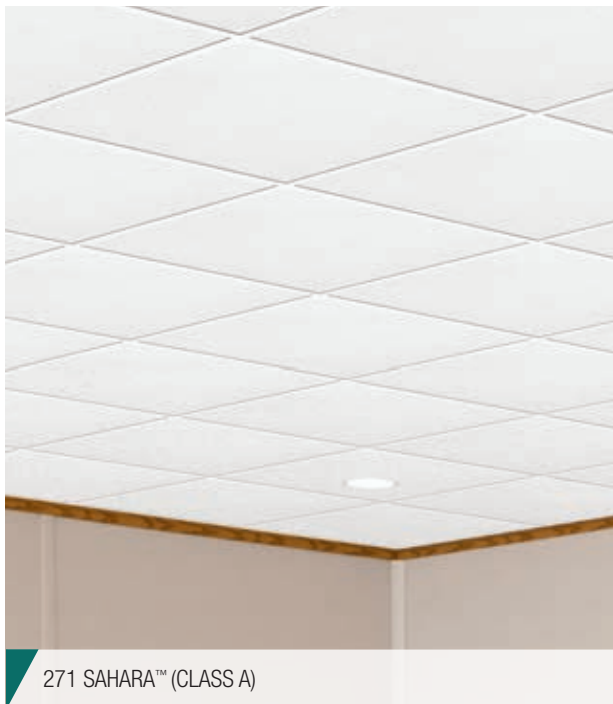

271 SAHARA™ (CLASS A)



915 Textured FIRE GUARD™ (FIRE RATED)

DRYWALL GRID INSTALLATION SYSTEMS

Drywall Grid Ceiling Framing System

| Item Number | Item Name | Length | Face Dimension | Profile Height | Duty Load | Fire Rated | Routs | Load Test Data (Lbs/LF) | | | | | | Perspective | Pcs/Ctn |
|-------------|-----------------|--------|----------------|----------------|------------|------------|--|-------------------------|------|-------|-------------------|-------|-------|-------------|---------|
| | | | | | | | | L/360 Simple Span | | | L/240 Simple Span | | | | |
| HD8906 | 12-ft Main Beam | 144-in | 1-1/2-in | 1-11/16-in | Heavy Duty | Yes | Routs 8-in O.C. | 95.5 | 35.8 | 18.76 | 139.85 | 52.24 | 28.14 | | 12 |
| HD8906F08G | 12-ft Main Beam | 144-in | 1-1/2-in | 1-11/16-in | Heavy Duty | Yes | 12-ft HD Drywall Main Beam—Faceted 8-in O.C. | — | — | 12.3 | — | — | 18.4 | | 12 |
| XL8945P | 4-ft CrossTee | 48-in | 1-1/2-in | 1-1/2-in | | Yes | 9 routs—center rout and starting 10-in from each end | | | 15.0 | | | 22.5 | | 36 |
| XL8926 | 2-ft CrossTee | 24-in | 1-1/2-in | 1-1/2-in | | Yes | 3 routs—center rout and 10" from each end | 90.25 | | | 158 | | | | 36 |

Membrane Load Values

| Component Combinations | Maximum Load in Lbs/SF at Hanger Wire/Cross Tee Spacing | | | | | | | |
|------------------------|---|-----|---------|-------|---------|-------|-------|------|
| | 48 / 24 | | 48 / 16 | | 36 / 16 | | | |
| | Main | Tee | L/240 | L/360 | L/240 | L/360 | | |
| HD8906 – XL8945P | | | 7.03 | 4.69 | 7.03 | 4.69 | 14.93 | 9.95 |

ShortSpan® Drywall System (for spaces <12-ft wide)

| Item Number | Length | Description | Face Dimension | Profile Height | O.C. Spacing | Load Test Data (Lbs/LF) L/240 per ASTM C 645 | | | | Perspective | Pcs/Ctn |
|-------------|--------|---|----------------|----------------|--------------|--|--------|-------|-------|-------------|---------|
| | | | | | | 7-ft | 8-ft | 10-ft | 12-ft | | |
| S7712P | 144-in | 12-ft ShortSpan® Tee | 1-1/2-in | 1-1/2-in | 16-ft | 2.80 | 18.38* | 9.54* | 4.87* | | 12 |
| SB12P | 144-in | StrongBack™ Drywall Support Bar (Pre-engineered solutions to support spans over 6-ft or 7-ft) | — | 2-in | 24-ft | — | 12.25* | 6.36* | 3.25* | | |

*Requires mid-span vertical support

Membrane Load Values—ShortSpan® (Maximum Load in Lbs/SF (L/240 per ASTM C 645))

| Item Number | Length | O.C. Spacing | 4-ft Span (Lbs/SF) | 5-ft Span (Lbs/SF) | 6-ft Span (Lbs/SF) | 7-ft Span (Lbs/SF) |
|-------------|--------|--------------|--------------------|--------------------|--------------------|--------------------|
| S7712P | 12-ft | 16-in | 18.38 | 9.97 | 4.87 | 2.80 |

Note: 5/8-in drywall weighs 2.4 Lbs/SF (tees installed 16-in or 24-in on center), 1/2-in drywall weighs 2.0 Lbs/SF (tees installed 16-in on center only)

Wall Molding

| Item Number | Length | Description | Profile | Perspective | Pcs/Ctn |
|-------------|--------|--|---------|-------------|---------|
| LAM12A | 144-in | Locking Angle Molding nominal 1-1/4-in x 1-1/4-in (for ShortSpan and QuikStix soffits) | | | 20 |
| KAM1510B | 120-in | Knurled Angle Molding nominal 1-1/2-in x 1-1/2-in | | | 10 |
| KAM1512B | 144-in | Knurled Angle Molding nominal 1-1/2-in x 1-1/2-in | | | 10 |

QuikStix™ Soffits

| Item Number | Length | Description | Face Dimension | Profile Height | Perspective | Pcs/Ctn |
|-------------|--------|---|----------------|----------------|-------------|---------|
| QS612 | 120-in | QuikStix™ Soffits (knockouts 6-in O.C.) 10-ft x 1-1/2-in x 1-1/2-in | 1-1/2-in | 1-1/2-in | | 10 |

QuikStix™ Soffit – Horizontal Soffit Span

| QS612 Placement | 12-in or 16-in (Lbs/LF) | 24-in | 36-in |
|-----------------|-------------------------|-------|-------|
| 16-in O.C. | 18.69 | 12.46 | 5.75 |
| 24-in O.C. | 12.46 | 8.63 | 3.83 |



Estimating Material

| Item number | Length | Pcs/Ctn | LF/Ctn | Lbs/Ctn | Area of ceiling completed by one carton | | | | | | | |
|--|--------|---------|--------|---------|---|------------|------------|------------|------------|------------|------------|---------|
| | | | | | 8-in O.C. | 16-in O.C. | 24-in O.C. | 36-in O.C. | 48-in O.C. | 50-in O.C. | 72-in O.C. | |
| DRYWALL GRID MAIN BEAM | | | | | | | | | | | | |
| HD8906 | 144" | 12 | 144 | 48 | | | 288 | 432 | 576 | 600 | 864 | sq. ft. |
| DRYWALL GRID 1-1/2" FACE CROSS TEES | | | | | | | | | | | | |
| XL8945P | 48" | 36 | 144 | 46 | 96 | 192 | 288 | | | | | sq. ft. |

| Item number | Length | Pcs/Ctn | LF/Ctn | Lbs/Ctn |
|------------------------------|--------|---------|--------|---------|
| DRYWALL ANGLE MOLDING | | | | |
| KAM1510B | 120-in | 10 | 240 | 20 |
| LAM12A | 144-in | 20 | 240 | 39 |

Accessories

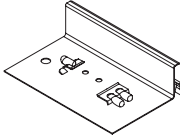
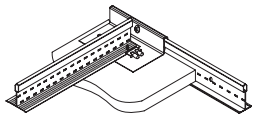
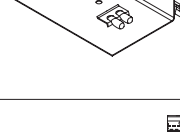
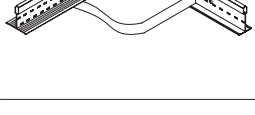
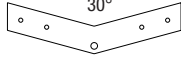
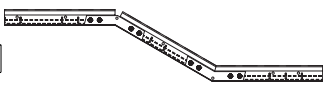
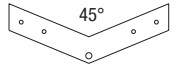
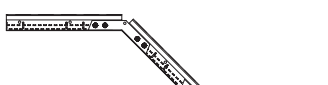
A variety of drywall grid accessories are available to provide problem-solving solutions that save time, labor and money.

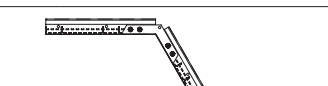
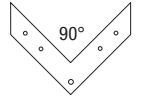
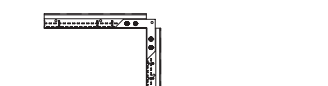
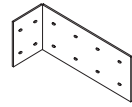
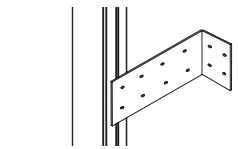
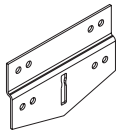
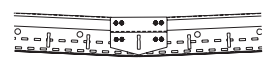
| Item Number | Description | Perspective | Application | Pcs / Ctn |
|-------------|---|--|---|-----------|
| DW50LTR | DW50LTR – Unpainted Transition Clips for 1/2" Drywall with Locking Tabs; facilitates transition from drywall to acoustical ceiling; one-sided hold-down clip; eliminates the need for a drywall bead. Locking tabs provide secure location for DGS tees. (12 pieces in a poly bag and 12 bags per box) |  |  | 144 |
| DW58LTR | DW58LTR – Unpainted Transition Clips for 5/8" Drywall with Locking Tabs; facilitates transition from drywall to acoustical ceiling; one-sided hold-down clip; eliminates need for drywall bead. Locking tabs provide secure location for Drywall Grid Systems tees. |  |  | 125 |
| DW30CAG | 30 Degree Unpainted Drywall Angle Clips are used to create positive and secure angles for drywall and ceiling installations on either main beams or cross tees |  |  | 250 |
| DW45CAG | 45 Degree Unpainted Drywall Angle Clips are used to create positive and secure angles for drywall and ceiling installations on either main beams or cross tees |  |  | 250 |
| DW60CAG | 60 Degree Unpainted Drywall Angle Clips are used to create positive and secure angles for drywall and ceiling installations on either main beams or cross tees |  |  | 250 |
| DW90CAG | 90 Degree Unpainted Drywall Angle Clips are used to create positive and secure angles for drywall and ceiling installations on either main beams or cross tees |  |  | 250 |
| QSUTCR | Unpainted QuikStix™ Uptight Clips 4-1/2-in x 1-1/2-in x 1 3/4-in (G90 Hot Dipped/12 pieces in a poly bag and 12 bags per box) |  |  | 144 |
| RC2R | Unpainted Radius Clips are used for drywall applications which form curved installations; attaches to the cavity side of web of the main beam with four 7/16-in pan head screws; install at all knockout locations |  |  | 205 |

Visit both ceilings.com and ceilings.com/dealertools for additional information and grid installation videos.

For the Easy Calculation of weight for your Grid Order, visit the **Grid Weight Estimator**, found on ceilings.com/dealertools



SURFACE MOUNT (DIRECT APPLY) CEILING INSTALLATION

- Want to hide stains or an ugly popcorn ceiling?
- Want to maximize your ceiling height?
- Don't like the look of grid?

Surface Mount (Direct Apply) ceiling tiles or planks install quickly and easily with Easy Up® installation system.

EasyUP[®]
INSTALLATION SYSTEM



1 Attach tracks (1190)



2 Snap on clips (1191 or 1191SC)



3 Position tile or plank; slide and secure clip



Easy Up® Tracks
Item #1190
(20 tracks per carton)



Easy Up® Clips
Item #1191
(360 clips per carton—
8 bags of 45 each)

Item #1191SC
(135 clips per carton)



WoodHaven™ plank installation using Easy Up® tracks and clips



▲ [Click link to watch video](#)

NOTE: Both track products and clip accessories are required for a complete Easy Up system and must be used together. Items are sold separately.

Surface Mount (Direct Apply) products can also be installed with adhesive such as Henry® 237 AcoustiGum™ Acoustical Ceiling Tile Adhesive. Follow adhesive manufacturer's instructions for application and usage.

Henry and AcoustiGum are trademarks of W.W. Henry Company or its Affiliates.

EASY UP® INSTALLATION SYSTEM

FOR DIRECT APPLY CEILING TILES AND PLANKS



- Provides greater dimensional stability and strength versus wood furring
- Eliminates tile lipping caused by warping wood furring
- Easy Up® clips provide superior holding versus traditional staples
- Easy Up clips may be able to be used on an existing 15/16-in grid ceiling to install WoodHaven™ planks
- Best method for installing planks over popcorn ceilings

CALCULATE TRACKS AND CLIPS NEEDED

| How to calculate tracks and clips needed: | | Example: |
|---|--|---|
| 1 | Find your ceiling product on the below chart | 12-in x 12-in Tile |
| 2 | Calculate the square footage of your room | 10-ft wide x 12-ft long room = 120 sf |
| 3 | Find the Track Ratio listed for your ceiling product on the chart | 1.10-lf of Track/sf |
| 4 | Multiply the sf by the ratio | 120 sf x 1.10 = 132 lf |
| 5 | Divide the result by 8-ft for total number of tracks required. Round up if necessary | 132 lf/8-ft = 16.5 (17 Tracks) (each track = 8-ft length) |
| 6 | Find the Clip Ratio listed for your ceiling product on the chart | 1.3 Clips/sf |
| 7 | Multiply the sf from step 2 by the ratio | 120 sf x 1.3 = 156 Clips |
| 8 | Round up if necessary for total number of clips required | 156 Clips |

Notes: Table averages values of room combinations from 10-ft x 10-ft to 30-ft x 30-ft. It is possible that these values could leave you slightly short, as it is an average. Values assume butting Track joints, end to end, with no overlap.

| Ceiling product | Track spacing | Ratio of lf of Track/sf of room | Ratio of Clips/sf of room |
|------------------------|---------------|---------------------------------|---------------------------|
| 12-in x 12-in Tile | 12-in oc | 1.10 | 1.30 |
| Country Classic™ Plank | 12-in oc | 1.10 | 1.25 |
| WoodHaven | 24-in oc | 0.65 | 1.20 |

oc = on center, lf = linear feet, sf = square feet

Please visit ceilings.com/projectestimator to access our online material estimator.

Download a copy of the Easy Up® Installation System Estimating Guide at ceilings.com/estimateeasyup



250 PINEHURST™ (CEILING)

WOODHAVEN™ CEILING PLANK

ESTIMATING

Installation materials included in every package of planks: 55 clips, 55 screws—enough to install one package of WoodHaven™ ceiling planks. (Installation also requires furring strips, which are sold separately.)



INSTALLATION



WOODHAVEN SURFACE MOUNT (DIRECT APPLY) CEILING

FIND YOUR ROOM SIZE AND SEE THE NUMBER OF WOODHAVEN CEILING PLANK CARTONS NEEDED

| | 4-ft | 5-ft | 6-ft | 7-ft | 8-ft | 9-ft | 10-ft | 11-ft | 12-ft | 13-ft | 14-ft | 15-ft | 16-ft | 17-ft | 18-ft | 19-ft | 20-ft |
|-------|------|------|------|------|------|------|-------|-------|-------|-------|-------|-------|-------|-------|-------|-------|-------|
| 4-ft | 1 | 1 | 1 | 1 | 2 | 2 | 2 | 2 | 2 | 2 | 2 | 3 | 3 | 3 | 3 | 3 | 4 |
| 5-ft | 1 | 1 | 2 | 2 | 2 | 2 | 2 | 2 | 3 | 3 | 3 | 3 | 3 | 3 | 4 | 4 | 4 |
| 6-ft | 1 | 2 | 2 | 2 | 2 | 2 | 3 | 3 | 3 | 3 | 3 | 4 | 4 | 4 | 4 | 4 | 5 |
| 7-ft | 1 | 2 | 2 | 2 | 2 | 3 | 3 | 3 | 3 | 4 | 4 | 4 | 4 | 5 | 5 | 5 | 5 |
| 8-ft | 2 | 2 | 2 | 2 | 3 | 3 | 3 | 4 | 4 | 4 | 4 | 5 | 5 | 5 | 5 | 6 | 6 |
| 9-ft | 2 | 2 | 2 | 3 | 3 | 3 | 4 | 4 | 4 | 5 | 5 | 5 | 5 | 6 | 6 | 6 | 7 |
| 10-ft | 2 | 2 | 3 | 3 | 3 | 4 | 4 | 4 | 5 | 5 | 5 | 6 | 6 | 6 | 7 | 7 | 7 |
| 11-ft | 2 | 2 | 3 | 3 | 4 | 4 | 4 | 5 | 5 | 5 | 6 | 6 | 7 | 7 | 7 | 8 | 8 |
| 12-ft | 2 | 3 | 3 | 3 | 4 | 4 | 5 | 5 | 5 | 6 | 6 | 7 | 7 | 8 | 8 | 8 | 9 |
| 13-ft | 2 | 3 | 3 | 4 | 4 | 5 | 5 | 5 | 6 | 6 | 7 | 7 | 8 | 8 | 9 | 9 | 9 |
| 14-ft | 2 | 3 | 3 | 4 | 4 | 5 | 5 | 6 | 6 | 7 | 7 | 8 | 8 | 9 | 9 | 10 | 10 |
| 15-ft | 3 | 3 | 4 | 4 | 5 | 5 | 6 | 6 | 7 | 7 | 8 | 8 | 9 | 9 | 10 | 10 | 11 |
| 16-ft | 3 | 3 | 4 | 4 | 5 | 5 | 6 | 7 | 7 | 8 | 8 | 9 | 9 | 10 | 10 | 11 | 12 |
| 17-ft | 3 | 3 | 4 | 5 | 5 | 6 | 6 | 7 | 8 | 8 | 9 | 9 | 10 | 10 | 11 | 12 | 12 |
| 18-ft | 3 | 4 | 4 | 5 | 5 | 6 | 7 | 7 | 8 | 9 | 9 | 10 | 10 | 11 | 12 | 12 | 13 |
| 19-ft | 3 | 4 | 4 | 5 | 6 | 6 | 7 | 8 | 8 | 9 | 10 | 10 | 11 | 12 | 12 | 13 | 14 |
| 20-ft | 4 | 4 | 5 | 5 | 6 | 7 | 7 | 8 | 9 | 9 | 10 | 11 | 12 | 12 | 13 | 14 | 14 |

Visit ceilings.com/projectestimator to access our online material estimator.

WoodHaven™
CEILING PLANKS

WOODHAVEN™ PLANK CEILING INSTALLATION OPTIONS

INSTALL ON CEILINGS IN THREE DIFFERENT WAYS

Before starting your project, review complete installation instructions at ceilings.com/installwoodhaven for important design and installation considerations.

1 WOODHAVEN™ CLIPS AND SCREWS



▲ [Click link to watch video](#)

Installation clips and screws are included in the plank package and install directly to furring strips (sold separately). This installation method is suitable for ceilings with a greater than 10 degree slope. Please contact Techline at 1-877-ARMSTRONG (276-7876) for guidance on how to install planks on a sloped ceiling.



▲ [Click link to watch video](#)

2 EASY UP® TRACKS AND CLIPS

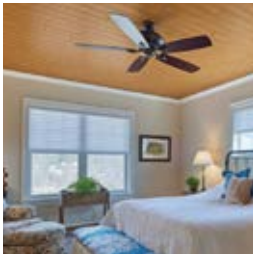

▲ [Click link to watch video](#)

The Easy Up® installation system is fast and easy with snap-on (vs. screw-in) clips, and is the recommended method to install planks over drywall, plaster or popcorn ceilings. Use the Easy Up® installation system for ceilings with a less than 10 degree slope.

Item #1190 (20 tracks per carton)

Item #1191 (360 clips per carton—8 bags of 45 each)
or Item #1191SC (135 clips per carton)

NOTE: Both track products and clip accessories are required for a complete Easy Up system and must be used together. Items are sold separately.

3 INSTALLATION STEPS TO RETROFIT 15/16-in GRID

Transform an existing 15/16-in suspended (drop) ceiling using Easy Up® clips and WoodHaven™ planks.



Remove panels



Snap on Easy Up clips



Position planks; slide and secure clips



▲ [Click link to watch video](#)

NOTE: Existing grid must be 15/16-in. Easy Up clips (sold separately) must be used for the retrofit installation. Screws and clips included in the WoodHaven package are only used where grid intersections interfere with the installation of an Easy Up clip.

Visit ceilings.com to order a sample Easy Up clip to test your grid for a snug fit.

Visit ceilings.com/installwoodhaven for full installation instructions and tips.

DESIGN/SPACE CONSIDERATIONS

- Material needs 2-3 days to acclimate to room conditions
- In ceiling applications, do not attach planks directly to roof structures, molding or walls
- Long runs of 21-ft or more require expansion joints

WoodHaven™
CEILING PLANKS

PRODUCT COMPARISON DATA

| Armstrong Ceilings Retail | Armstrong Ceilings Commercial | USG Retail | USG Commercial | CertainTeed Commercial |
|-----------------------------------|--|----------------------|-----------------------------|-------------------------------|
| 231 Washable White | None | 4290 Custom White | None | None |
| 241 SuperTuff™ | 303 Tundra® | None | 5899 Touchstone | None |
| 258 Grenoble™ | None | 4240 Tivoli | None | None |
| 266 Brighton™ | None | 1004 Alpine | None | None |
| 269 Sand Pebble™ | 1752 Georgian™ | R4800 Moonscape | 4805 Pebbled | BET-154 Baroque |
| 271 Sahara™ | 1774 Dune™ | 5221 Majestic | 4221 Olympia Micro | SHM-154 Sand Micro |
| 273 Sahara™ | 1772 Dune™ | None | 4211 Olympia Micro | SHM-157 Sand Micro |
| 276 Sahara™ | 1775 Dune™ | None | 4231 Olympia Micro | SHM-150 Sand Micro |
| 280 Plain White | None | 380 Stonehurst | None | None |
| 403 Esprit® Fiberglass | None | 209 Tabaret | None | None |
| 410 Random Fissured™ | 2911 Random Fissured™ | None | 7053G Premier Hi-Lite | 1530-VIN-1 Versatone |
| 490 Yuma White® | 1490 Canyon® | None | 62156 Orion | None |
| 491 Yuma White® | 1491 Canyon® | None | 62157 Orion | None |
| 492 Yuma White® | 1492 Canyon® | None | None | None |
| 493 Yuma White® | 1493 Canyon® | None | None | None |
| 915 Textured FIRE GUARD™ | 895 Fissured FIRE GUARD™ | 220 Fifth Avenue | 586 Fissured | None |
| 922 Fine Fissured™ | 1729 Fine Fissured™ | R2410 Radar | 2410 Radar | HHF-197 Fine Fissured |
| 928 Fine Fissured™ | 1728 Fine Fissured™ | None | 2210 Radar | HHF-157 Fine Fissured |
| 932 Fine Fissured™ | 1732 Fine Fissured™ | R2220 Radar | 2220 Radar | HHF-154 Fine Fissured |
| 933 Random Textured | 769A Cortega® | R2310 Radar | 2310 Radar | BET-197 Baroque |
| 934 Random Textured | 704 Cortega® | R2120 Radar | 2120 Radar | BET-154 Baroque |
| 935 Random Textured | 770 Cortega® | R2110 Radar | 2110 Radar | BET-157 Baroque |
| 942 Textured | 755 Fissured | 280 Fifth Avenue | 562 Fissured | DMRF-197 Directional Fissured |
| 949 Textured | 756 Fissured | 133 Fifth Avenue | 560 Fissured | DMRF-157 Directional Fissured |
| 954 Classic Fine Textured | 584 Cirrus® Angled Tegular | R76775 Luna | 76775 Eclipse | CM-454 Cashmere® |
| 972 Lumawash® | 672 Kitchen Zone™ | R3270 Sheetrock® | R3270 Sheetrock® | 1140-CRF-1 Vinylrock |
| 973 Lumawash® | 673 Kitchen Zone™ | R3260 Sheetrock® | R3260 Sheetrock® | 1142-CRF-1 Vinylrock |
| 1148 WoodHaven™ Painted White | 1480WHT Lineage™ Painted White | None | None | None |
| 1201 Raised Panel™ | 8011 Ledges® | None | None | None |
| 1210 Single Raised Panel | 8013 Ledges® | None | None | None |
| 1231 Brightex™ w/AirGuard™ | 1902 Ultima® w/AirGuard™ | None | None | None |
| 1264 WoodHaven™ Rustic Pine | 1480RPN Lineage™ Rustic Pine | None | None | None |
| 1265 WoodHaven™ White Wash | 1480WHW Lineage™ White Wash | None | None | None |
| 1268 WoodHaven™ Natural Cherry | 1480NCH Lineage™ Natural Cherry | None | None | None |
| 1728BL Fine Fissured™ Black | 1728BL Fine Fissured™ Tech Black | None | None | None |
| 2012 AcoustAffix® Field Paintable | 1212FP InvisAcoustics™ Field Paintable | None | None | None |
| 2012WH AcoustAffix® White | 1212WH InvisAcoustics™ White | None | None | None |
| 2012BL AcoustAffix® Black | 1212BL InvisAcoustics™ Black | None | None | None |
| 8008 TinCraft™ Circles | 8008 TinCraft™ Circles | None | None | None |
| 8009 TinCraft™ Squares | 8009 TinCraft™ Squares | None | None | None |
| 9767 Scored | 2767 Cortega® Second Look® II | R2742 Radar Illusion | 2742 Radar Illusion | BQCL-224 Baroque Customline® |
| 9768 Sahara™ Scored II | 2712 Dune™ Second Look® | None | 4742 Olympia Micro Illusion | None |
| 9769 Sahara™ Scored I | 2711 Dune™ Second Look® | None | None | None |

Note: This product comparison list is intended as a guide and is not meant to represent that products within the same category are identical substitutes. Please consult Manufacturer's Catalogs for specific technical data and U.L. designs required.

AcoustAffix, AirGuard, Brightex, Brighton, Canyon, Cirrus, Cortega, Dune, Esprit, Fine Fissured, Fire Guard, Georgian, Grenoble, InvisAcoustics, Kitchen Zone, Ledges, Lineage, Lumawash, Raised Panel, Random Fissured, Sahara, Sand Pebble, Second Look, SuperTuff, TinCraft, Tundra, Ultima, Yuma White and WoodHaven are trademarks or registered trademarks of AWI Licensing LLC and/or its affiliates in the U.S.A. and/or other countries.

All other registered trademarks are property of their respective owners.

PERFORMANCE AND INSTALLATION METHOD GUIDE BY ITEM

| Retail Item # | Retail Item Name | Size (Inches) | Edge Detail | Installation Method** | Fire Class | Sag Resistance | Mold/Mildew Resistance | NRC | CAC | LR | Recycled Material Content |
|---------------|-------------------------------|---------------|-------------------------|--|------------|----------------|------------------------|------|-----|------|---------------------------|
| 46 | Wellington™ | 12 x 12 x 1/2 | Square Tongue & Groove | Surface Mount (Direct Apply) | A | Standard | Standard | — | 30 | 0.76 | 40% |
| 231 | Washable White | 12 x 12 x 1/2 | Beveled Tongue & Groove | Surface Mount (Direct Apply) | A | Standard | Standard | — | 30 | 0.80 | 24% |
| 241 | SuperTuff™ | 24 x 24 x 5/8 | Tegular | Suspended (Drop) | A | Superior | Superior | 0.50 | 33 | 0.86 | 33% |
| 250 | Pinehurst™ | 12 x 12 x 1/2 | Beveled Tongue & Groove | Surface Mount (Direct Apply) | A | Standard | Standard | — | 30 | 0.80 | 24% |
| 258 | Grenoble™ | 12 x 12 x 1/2 | Beveled Tongue & Groove | Surface Mount (Direct Apply) | A | Standard | Standard | — | 30 | 0.80 | 24% |
| 266 | Brighton™ | 24 x 24 x 1/2 | Tegular | Suspended (Drop) | A | Standard | Superior | 0.45 | 30 | 0.86 | 25% |
| 269 | Sand Pebble™ | 24 x 24 x 5/8 | Tegular | Suspended (Drop) | A | Superior | Superior | 0.55 | 30 | 0.80 | 41% |
| 271 | Sahara™ | 24 x 24 x 5/8 | Tegular | Suspended (Drop) | A | Superior | Superior | 0.50 | 35 | 0.81 | 41% |
| 273 | Sahara | 24 x 24 x 5/8 | Square | Suspended (Drop) | A | Superior | Superior | 0.50 | 35 | 0.81 | 41% |
| 276 | Sahara | 24 x 24 x 5/8 | Tegular | 9/16-in Suspended (Drop) | A | Superior | Superior | 0.50 | 35 | 0.81 | 41% |
| 280 | Plain White | 24 x 48 x 1/2 | Square | Suspended (Drop) | A | Standard | Standard | — | 30 | 0.80 | 24% |
| 297 | Grenoble™ | 24 x 48 x 1/2 | Square | Suspended (Drop) | A | Standard | Standard | — | 30 | 0.80 | 24% |
| 403 | Esprit® | 24 x 48 x 5/8 | Square | Suspended (Drop) | A | Superior | Superior | 0.55 | — | 0.72 | 82% |
| 410 | Sonoflex™ Random Fissured™ | 24 x 48 x 5/8 | Square | Suspended (Drop) | A | Superior | Superior | 0.55 | — | 0.72 | 82% |
| 416 | Sonoflex Etched | 24 x 48 x 5/8 | Square | Suspended (Drop) | A | Superior | Superior | 0.55 | — | 0.72 | 82% |
| 480 | Country Classic™ Plank | 6 x 48 x 1/2 | Beveled Tongue & Groove | Surface Mount (Direct Apply) | A | Standard | Standard | — | 30 | 0.80 | 22% |
| 490 | Yuma White® | 24 x 24 x 5/8 | Square | Suspended (Drop) | A | Superior | Superior | 0.55 | 35 | 0.80 | 44% |
| 491 | Yuma White | 24 x 48 x 5/8 | Square | Suspended (Drop) | A | Superior | Superior | 0.55 | 35 | 0.80 | 44% |
| 492 | Yuma White | 24 x 24 x 5/8 | Tegular | Suspended (Drop) | A | Superior | Superior | 0.55 | 35 | 0.80 | 44% |
| 493 | Yuma White | 24 x 48 x 5/8 | Tegular | Suspended (Drop) | A | Superior | Superior | 0.55 | 35 | 0.80 | 44% |
| 915* | Textured FIRE GUARD™ | 24 x 48 x 5/8 | Square | Suspended (Drop) | A | Standard | Standard | 0.55 | 35 | 0.79 | 38% |
| 922 | Fine Fissured™ | 24 x 48 x 5/8 | Square | Suspended (Drop) | A | Superior | Superior | 0.55 | 35 | 0.82 | 40% |
| 928 | Fine Fissured | 24 x 24 x 5/8 | Square | Suspended (Drop) | A | Superior | Superior | 0.55 | 33 | 0.82 | 40% |
| 932 | Fine Fissured | 24 x 24 x 5/8 | Tegular | Suspended (Drop) | A | Superior | Superior | 0.55 | 35 | 0.82 | 40% |
| 933 | Random Textured | 24 x 48 x 5/8 | Square | Suspended (Drop) | A | Standard | Standard | 0.55 | 35 | 0.80 | 30% |
| 934 | Random Textured | 24 x 24 x 5/8 | Tegular | Suspended (Drop) | A | Standard | Standard | 0.55 | 33 | 0.80 | 30% |
| 935 | Random Textured | 24 x 24 x 5/8 | Square | Suspended (Drop) | A | Standard | Standard | 0.55 | 33 | 0.80 | 30% |
| 942 | Textured | 24 x 48 x 5/8 | Square | Suspended (Drop) | A | Standard | Standard | 0.55 | 30 | 0.79 | 30% |
| 949 | Textured | 24 x 24 x 5/8 | Square | Suspended (Drop) | A | Standard | Standard | 0.55 | 33 | 0.79 | 30% |
| 954 | Classic Fine Textured | 24 x 24 x 3/4 | Tegular | Suspended (Drop) | A | Superior | Superior | 0.70 | 35 | 0.85 | 67% |
| 972 | Lumawash® | 24 x 48 x 5/8 | Square | Suspended (Drop) | A | Superior | Superior | — | 33 | 0.89 | 36% |
| 973 | Lumawash | 24 x 24 x 5/8 | Square | Suspended (Drop) | A | Superior | Superior | — | 33 | 0.89 | 36% |
| 1148 | WoodHaven Painted White | 5 x 84 x 3/8 | Beveled Tongue & Groove | Surface Mount (Direct Apply) | C | Standard | Standard | — | — | 0.85 | 95% |
| 1149 | WoodHaven Beadboard | 5 x 84 x 3/8 | Beveled Tongue & Groove | Surface Mount (Direct Apply) | C | Standard | Standard | — | — | 0.85 | 95% |
| Various (V) | WoodHaven | 5 x 84 x 3/8 | Beveled Tongue & Groove | Surface Mount (Direct Apply) | C | Standard | Standard | — | — | — | 95% |
| 1201 | Raised Panel™ | 24 x 24 x 5/8 | Tegular | Suspended (Drop) | A | Standard | Standard | — | 30 | 0.78 | 52% |
| 1202 | Scalloped | 24 x 24 x 5/8 | Tegular | Suspended (Drop) | A | Standard | Standard | — | 30 | 0.78 | 52% |
| 1203 | Fluted | 24 x 24 x 5/8 | Tegular | Suspended (Drop) | A | Standard | Standard | — | 30 | 0.78 | 52% |
| 1205 | Single Raised Panel | 24 x 24 x 5/8 | Tegular | Suspended (Drop) | A | Standard | Standard | — | 30 | 0.78 | 52% |
| 1206 | Tango | 24 x 24 x 5/8 | Tegular | Suspended (Drop) | A | Standard | Standard | — | 30 | 0.78 | 52% |
| 1210 | Single Raised Panel | 24 x 24 x 3/4 | Tegular | 9/16-in Suspended (Drop) | A | Standard | Standard | — | 30 | 0.78 | 52% |
| 1231 | Brightex™ with AirGuard™ | 24 x 24 x 3/4 | Tegular | 9/16-in Suspended (Drop) | A | Superior | Superior | 0.65 | 35 | 0.88 | 55% |
| 1240 | TinTile™ | 12 x 12 x 1/2 | Square Tongue & Groove | Surface Mount (Direct Apply) | A | Standard | Standard | — | 30 | 0.80 | 40% |
| 1244 | Circles | 12 x 12 x 1/2 | Square Tongue & Groove | Surface Mount (Direct Apply) | A | Standard | Standard | — | 30 | 0.80 | 40% |
| 1270 | Cascade® | 24 x 24 x 3/4 | Tegular | Suspended (Drop) | A | Standard | Standard | — | 30 | 0.80 | 25% |
| Various (V) | Easy Elegance™ Coffers | Various | Tegular | Suspended (Drop) | A | Superior | Superior | — | — | (V) | — |
| Various | Easy Elegance Flat Panels | Various | Square | Suspended (Drop) | A | Superior | Superior | — | — | (V) | — |
| Various | Easy Elegance Textured Panels | Various | Square | Suspended (Drop) | A | Superior | Superior | — | — | (V) | — |
| 1728BL | Fine Fissured—Black | 24 x 24 x 5/8 | Square | Suspended (Drop) | A | Superior | Superior | 0.55 | 33 | 0.06 | 40% |
| 2012WH | AcoustAffix® White | 24 x 48 x 3/4 | Square/Reverse Tegular | Surface Mount (Direct Apply) | A | Superior | Superior | 0.75 | — | — | 50% |
| 2012BL | AcoustAffix Black | 24 x 48 x 3/4 | Square/Reverse Tegular | Surface Mount (Direct Apply) | A | Superior | Superior | 0.75 | — | — | 50% |
| 2012 | AcoustAffix Field Paintable | 24 x 48 x 3/4 | Square | Surface Mount (Direct Apply) | A | Superior | Superior | 0.75 | — | — | 50% |
| 8008 | TinCraft™ Circles | 24 x 24 x 3/4 | Tegular | Suspended (Drop) | A | Standard | Standard | — | 35 | 0.78 | 52% |
| 8009 | TinCraft Squares | 24 x 24 x 3/4 | Tegular | 9/16-in Suspended (Drop) | A | Standard | Standard | — | 35 | 0.78 | 52% |
| 9767 | Scored | 24 x 48 x 3/4 | Tegular | Suspended (Drop) | A | Standard | Standard | 0.55 | 35 | 0.82 | 29% |
| 9768 | Sahara™ Scored II | 24 x 48 x 3/4 | Tegular | Suspended (Drop) | A | Superior | Superior | 0.50 | 35 | 0.81 | 43% |
| 9769 | Sahara™ Scored I | 24 x 48 x 3/4 | Tegular | Suspended (Drop) | A | Superior | Superior | 0.50 | 35 | 0.81 | 43% |
| Various | Metallaire™ | Various | Square | Suspended (Drop) or Surface Mount (Direct Apply) | A | Superior | Superior | — | — | — | 54% |

* Fire Guard™: a fire resistive ceiling when used in applicable UL assemblies

NOTE: Noise reduction coefficient (NRC), ceiling attenuation class (CAC), light reflectance (LR) and flame spread ratings are expressed according to ASTM E 1264 requirements.

** Suspended (Drop) Ceilings install on 15/16-in Prelude® grid unless otherwise specified.

PACKAGING GUIDE BY ITEM

| Retail Item # | Retail Item Name | Size (Inches) | Edge Detail | SF Per Ctn | Pcs/Ctn | Lbs/Ctn | Ctns Per Pallet | Layers Per Pallet | Warranty |
|---------------|-------------------------------|---------------|-------------------------|----------------|---------|---------|-----------------|-------------------|------------|
| 46 | Wellington™ | 12 x 12 x 1/2 | Square Tongue & Groove | 40 | 40 | 33 | 48 | 8 | 10/30-year |
| 231 | Washable White | 12 x 12 x 1/2 | Beveled Tongue & Groove | 40 | 40 | 28 | 48 | 8 | 10/30-year |
| 241 | SuperTuff™ | 24 x 24 x 5/8 | Tegular | 48 | 12 | 52 | 40 | 10 | 10/30-year |
| 250 | Pinehurst™ | 12 x 12 x 1/2 | Beveled Tongue & Groove | 40 | 40 | 28 | 48 | 8 | 10/30-year |
| 258 | Grenoble™ | 12 x 12 x 1/2 | Beveled Tongue & Groove | 40 | 40 | 28 | 48 | 8 | 10/30-year |
| 266 | Brighton™ | 24 x 24 x 1/2 | Tegular | 64 | 16 | 43 | 40 | 10 | 1-year |
| 269 | Sand Pebble™ | 24 x 24 x 5/8 | Tegular | 64 | 16 | 43 | 36 | 9 | 10/30-year |
| 271 | Sahara™ | 24 x 24 x 5/8 | Tegular | 64 | 16 | 60 | 32 | 9 | 10/30-year |
| 273 | Sahara | 24 x 24 x 5/8 | Square | 64 | 16 | 51 | 32 | 9 | 10/30-year |
| 276 | Sahara | 24 x 24 x 5/8 | Tegular | 64 | 16 | 48 | 32 | 8 | 10/30-year |
| 280 | Plain White | 24 x 48 x 1/2 | Square | 64 | 8 | 44 | 44 | 22 | 1-year |
| 297 | Grenoble | 24 x 48 x 1/2 | Square | 64 | 8 | 44 | 44 | 22 | 1-year |
| 403 | Esprit® | 24 x 48 x 5/8 | Square | 128 | 16 | 22 | 18 | 18 | 10/30-year |
| 410 | Sonoflex™ Random Fissured™ | 24 x 48 x 5/8 | Square | 128 | 16 | 22 | 18 | 13 | 10/30-year |
| 416 | Sonoflex Etched | 24 x 48 x 5/8 | Square | 128 | 16 | 22 | 18 | 9 | 10/30-year |
| 480 | Country Classic™ Plank | 6 x 48 x 1/2 | Beveled Tongue & Groove | 40 | 20 | 33 | 48 | 16 | 10/30-year |
| 490 | Yuma White® | 24 x 24 x 5/8 | Square | 64 | 16 | 49 | 36 | 9 | 10/30-year |
| 491 | Yuma White | 24 x 48 x 5/8 | Square | 64 | 8 | 49 | 36 | 18 | 10/30-year |
| 492 | Yuma White | 24 x 24 x 5/8 | Tegular | 64 | 16 | 49 | 36 | 9 | 10/30-year |
| 493 | Yuma White | 24 x 48 x 5/8 | Tegular | 64 | 8 | 49 | 34 | 17 | 10/30-year |
| 915 | Textured FIRE GUARD™ | 24 x 48 x 5/8 | Square | 64 | 8 | 71 | 36 | 18 | 1-year |
| 922 | Fine Fissured™ | 24 x 48 x 5/8 | Square | 64 | 8 | 45 | 36 | 14 | 10/30-year |
| 928 | Fine Fissured | 24 x 24 x 5/8 | Square | 64 | 16 | 45 | 36 | 9 | 10/30-year |
| 932 | Fine Fissured | 24 x 24 x 5/8 | Tegular | 64 | 16 | 53 | 36 | 9 | 10/30-year |
| 933 | Random Textured | 24 x 48 x 5/8 | Square | 80 | 10 | 53 | 30 | 15 | 1-year |
| 934 | Random Textured | 24 x 24 x 5/8 | Tegular | 64 | 16 | 44 | 36 | 9 | 1-year |
| 935 | Random Textured | 24 x 24 x 5/8 | Square | 64 | 16 | 41 | 36 | 9 | 1-year |
| 942 | Textured | 24 x 48 x 5/8 | Square | 80 | 10 | 53 | 30 | 15 | 1-year |
| 949 | Textured | 24 x 24 x 5/8 | Square | 64 | 16 | 41 | 36 | 9 | 1-year |
| 954 | Classic Fine Textured | 24 x 24 x 3/4 | Tegular | 48 | 12 | 51 | 36 | 9 | 10/30-year |
| 972 | Lumawash® | 24 x 48 x 5/8 | Square | 64 | 8 | 45 | 36 | 18 | 10/30-year |
| 973 | Lumawash | 24 x 24 x 5/8 | Square | 64 | 16 | 44 | 36 | 9 | 10/30-year |
| Various (V) | WoodHaven™ | 5 x 84 x 3/8 | Beveled Tongue & Groove | 29 | 10 | 47 | 48 | 6 | 10-year |
| 1190 | Easy Up® Tracks | 8-ft | — | LF/Per Ctn-160 | 20 | 17 | 24 | 8 | 30-year |
| 1191 | Easy Up Clips | — | — | — | 360 | 5 | 39 | 3 | 30-year |
| 1201 | Raised Panel™ | 24 x 24 x 5/8 | Tegular | 24 | 6 | 19 | 36 | 9 | 10-year |
| 1202 | Scalloped | 24 x 24 x 5/8 | Tegular | 24 | 6 | 22 | 36 | 9 | 10-year |
| 1203 | Fluted | 24 x 24 x 5/8 | Tegular | 24 | 6 | 22 | 36 | 9 | 10-year |
| 1205 | Single Raised Panel | 24 x 24 x 5/8 | Tegular | 24 | 6 | 22 | 36 | 9 | 10-year |
| 1206 | Tango | 24 x 24 x 5/8 | Tegular | 24 | 6 | 22 | 36 | 9 | 10-year |
| 1210 | Single Raised Panel | 24 x 24 x 3/4 | Tegular | 24 | 6 | 22 | 36 | 9 | 10-year |
| 1231 | Brightex™ with AirGuard™ | 24 x 24 x 3/4 | Tegular | 32 | 8 | 35 | 56 | 14 | 10/30-year |
| 1240 | TinTile™ | 12 x 12 x 1/2 | Square Tongue & Groove | 40 | 40 | 33 | 48 | 8 | 10/30-year |
| 1244 | Circles | 12 x 12 x 1/2 | Square Tongue & Groove | 40 | 40 | 35 | 48 | 8 | 10/30-year |
| 1270 | Cascade® | 24 x 24 x 3/4 | Tegular | 48 | 12 | 37 | 40 | 10 | 1-year |
| Various (V) | Easy Elegance™ Coffers | Various | Tegular | 4 | 1 | V | V | V | Lifetime |
| Various | Easy Elegance Flat Panels | Various | Square | Various | V | V | V | V | Lifetime |
| Various | Easy Elegance Textured Panels | Various | Square | Various | V | V | V | V | Lifetime |
| 1728BL | Fine Fissured-Black | 24 x 24 x 5/8 | Square | 64 | 16 | 52 | 36 | 9 | 10/30-year |
| 2012WH | AcoustAffix® White | 24 x 48 x 3/4 | Square/Reverse Tegular | 48 | 6 | 52 | 36 | 18 | 5-year |
| 2012BL | AcoustAffix Black | 24 x 48 x 3/4 | Square/Reverse Tegular | 48 | 6 | 52 | 36 | 18 | 5-year |
| 2012 | AcoustAffix Field Paintable | 24 x 48 x 3/4 | Square | 48 | 6 | 52 | 36 | 18 | 5-year |
| 8008 | TinCraft™ Circles | 24 x 24 x 3/4 | Tegular | 48 | 12 | 43 | 40 | 10 | 1-year |
| 8009 | TinCraft Squares | 24 x 24 x 3/4 | Tegular | 32 | 8 | 59 | 52 | 10 | 1-year |
| 9767 | Scored | 24 x 48 x 3/4 | Tegular | 80 | 10 | 59 | 24 | 12 | 1-year |
| 9768 | Sahara™ Scored II | 24 x 48 x 3/4 | Tegular | 64 | 8 | 56 | 24 | 12 | 10/30-year |
| 9769 | Sahara™ Scored I | 24 x 48 x 3/4 | Tegular | 64 | 8 | 56 | 24 | 12 | 10/30-year |
| Various | Metallaire™ | Various | Square | V | V | V | V | V | Lifetime |



5424234NLS METALLAIRE™ MEDALLION—NAIL-UP, LACQUERED STEEL (CEILING)



1279BL EASY ELEGANCE™ FLAT BLACK (CEILING)

If you have ceiling or wall questions, call: **1-877-ARMSTRONG (276-7876)**

NOTE: Due to printing limitations, colors pictured cannot be guaranteed to match actual ceiling and wall materials.

Titebond® and GREENChoice are trademarks of Franklin International.

Henry® and AcoustiGum™ are trademarks of W.W. Henry Company or its Affiliates.

All other trademarks are property of AWI Licensing LLC or affiliates, or their respective owners.

©2022 AWI Licensing LLC.

Printed in the United States of America

[ceiling.com](https://www.ceiling.com)



COVER PHOTO: 1264 WOODHAVEN™ RUSTIC PINE (CEILING)

Armstrong®
CEILING